

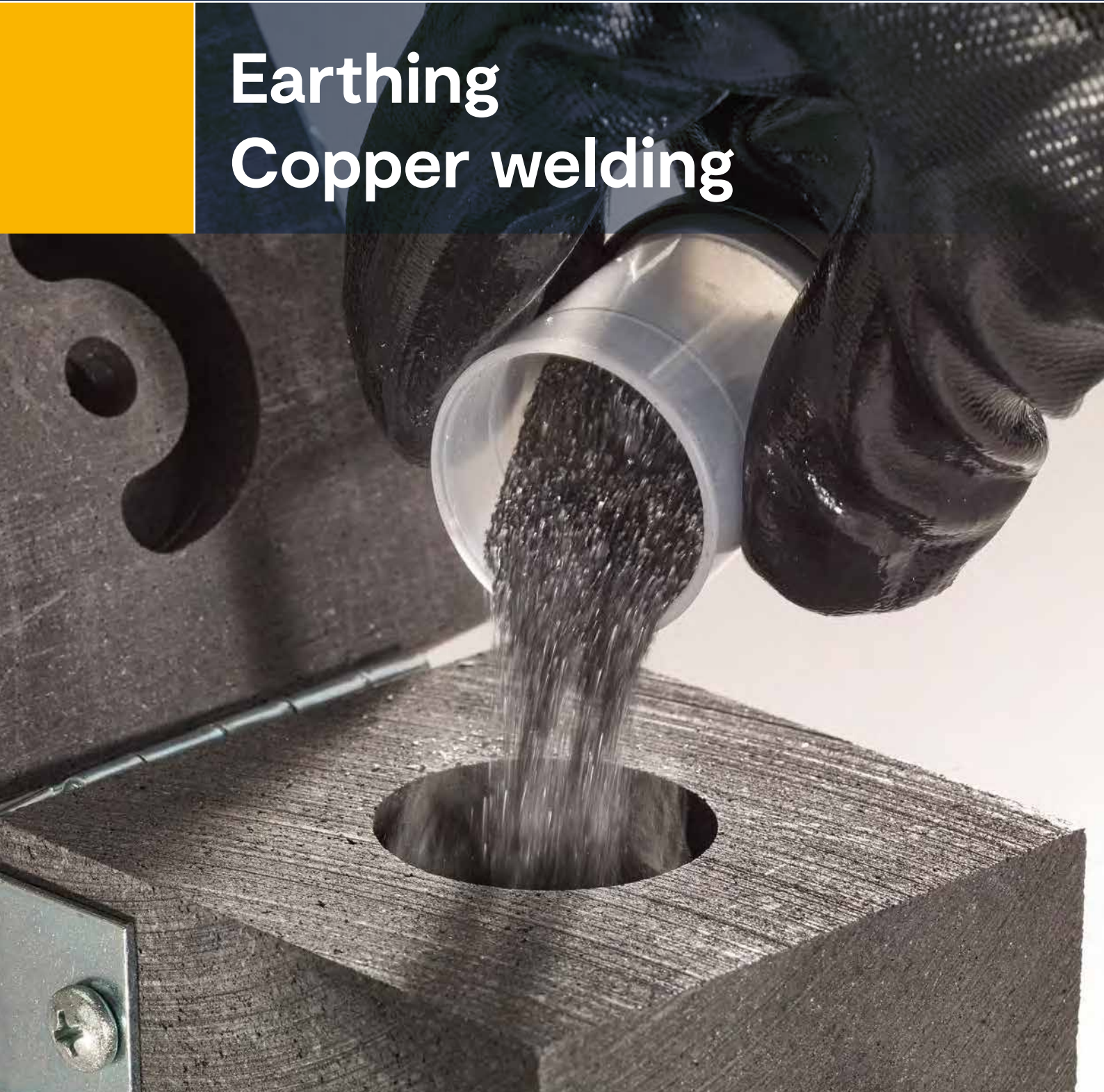

Committed to service

English

Earthing Copper welding





#weareK L K:

We are a young 50-year-old company with a long history in the industry, with experienced people who have been joined by a new generation of talents with the desire to go further and with new market ideas.

The result of this is the catalog that we present here, a young but experienced catalog, sober but modern, with the main idea of bringing our business closer to our existing and future customers with the same quality and customer focus as ever.

With this philosophy, we apply Quality, **Safety and Health, Environment policies**, throughout our business activities, based on the **ISO 9001, ISO 45001 and ISO 14001** standards.

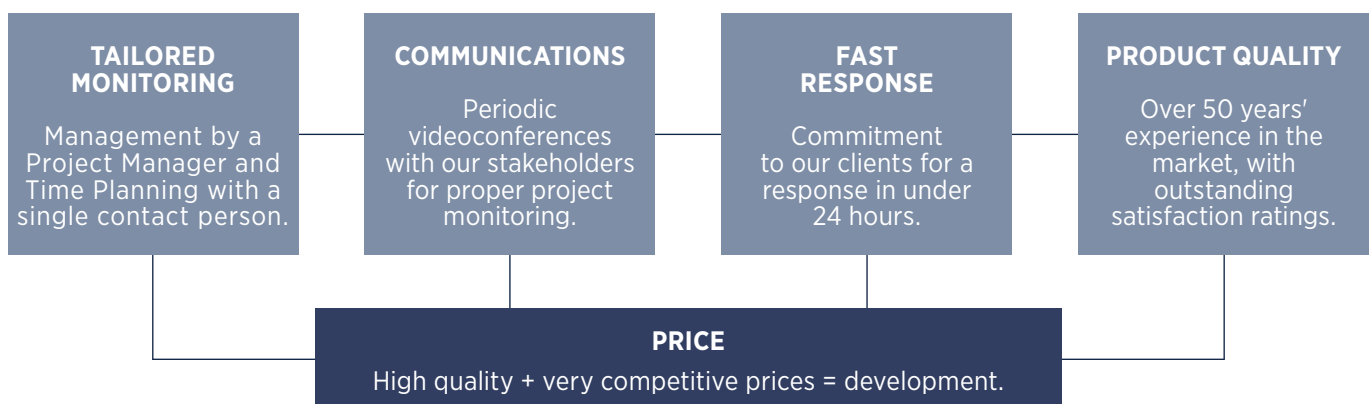

















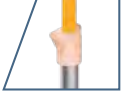
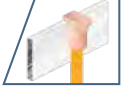



Table of contents

	1. Earth electrode	8
	1.1 Earth rods	8
	1.2 Earthing rod accessories	12
	1.3 Rod connection	15
	1.4 Plate and crowfoot	16
	2. Connection for round and flat conductor	17
	2.1 Connectors	17
	2.2 Cross, splice and earthing connectors	23
	3. Fixing accessories for flat and round conductors	27
	3.1 Tightening clamps, washers and supports	27
	3.2 Terminals	30
	3.3 Vertical and horizontal fixings	33
	3.4 Fixings for roofs	36

4. Protection against-lightning.....		37
	4.1 P.D.A.....	37
	4.2 Lightning arrester.....	38
	4.3 Supports.....	39
	4.4 Accessoires for down pipes.....	40
5. Equipotential links.....		44
	5.1 Solid copper slotted and threaded bars	44
	5.2 Equipotentiality bars.....	45
	5.3 Flanges.....	48
6. Conductors.....		50
	6.1 Conductors	50
	6.2 Round conductors.....	51
	6.3 Flat Conductors	51
	6.4 Copper and steel conductors.....	52
	6.5 Round and flat braids.....	53

	7. Copper aluminothermic welding 55
	Cartridges..... 56
	KLK-weld equipment 57
	Tables of cables, bus-bars and earth rods 58
	7.1 Cable / Cable 62
	7.2 Cable / Rod..... 73
	7.3 Rod / Rod 78
	7.4 Cable / Re-bar 79
	7.5 Cable / Metal plate 85
	7.6 Cable / Pipe..... 93
	7.7 Cable / Bus-bar 94
	7.8 Bus-bar / Bus-bar 102
	7.9 Ignition procedure LsVIP 111
	7.10 Virtual reality training 116
	7.11 Procedure ELPA-Tubo 118
	7.12 Procedure ELPA 123

Earthing

Why Earthing?

- **Main purpose: Limit ground voltage.**

The earthing system must ensure that there are no dangerous differences in potential in the installations, buildings and the surrounding area, while at the same time allowing fault currents or atmospheric discharges to be grounded.

- **The choice and installation of materials that ensure grounding must be such that:**

The earthing resistance value matches the installation's protection and operating standards and that this is maintained in this over time, taking into account the general requirements given in ITC-BT 24 and the Technical Instructions applicable to each installation.

A variety of elements can be used, such as plates, platens, etc. However, as it is the most widely-used type of electrode in the world, we recommend cylindrical rods, which are proven to be efficient and economical to install.

With a steel core and a thick layer of pure electrolytic copper molecularly bonded together, you get:

- * **Great mechanical rigidity.**
- * **Maximum corrosion resistance.**

The electrode burial depth should be measured from the top of the electrode and never less than 0.5 m. This ensures that the resistance of the earth connection does not increase above the rated value.

- **There are two ways to perform grounding with rodss:**

1. **Parallel system:** the most widely used in buildings and homes, as it does not require special machinery and is easy to install.
2. **Depth system:** used in confined spaces where rods cannot be installed in parallel. It consists of sinking a rod into the ground on top of another one. The two are connected with a coupling sleeve.

- **Applicable regulations for rods:**

- * **UNE 21.056**
- * **UNE 202006**

- **Minimum applicable dimensions:**

Ø 14,2 mm (steel-copper 100 µ)

- **Low Voltage Electrotechnical Regulation and its complementary technical Instructions.**

1. Earthing electrodes /

1.1 Earthing rods

Copperbond rods

Description Manufactured from a high strength steel core which is applied a copper plating molecularly bonded to the steel.

Material **Core:** steel.
Plating: copper.

All our rod electrodes are marked on the surface with the **KLK** logo and the corresponding type.

Note: Nominal and shank diameters do not correspond as they are threaded by rolling process.

Type UNE 202006 - 100 microns

Types	Length. mm x Ø nominal dia (mm)	Ø Shank dia (mm)	Kg/U
1,5 UNE 202006 142 ①	1.500 x 14,2	14,2	1,875
2 UNE 202006 142 ①	2.000 x 14,2	14,2	2,500
1,5 100M 180*	1.500 x 18,0	18,0	1,875
2 100M 180*	2.000 x 18,0	18,0	2,500

Only supplied unthreaded.

* Compliant with Standard copper thickness and length.

Type E - 350 microns

Types	Cat. ref. Threaded	Type Self-coupled	Length (mm) x Ø nominal dia (")	Ø Shank dia (mm)	Kg/U
E-10 34	E-10 34-RR	E-10 34-AA	1.000 x 3/4"	14,20	1,875
E-15 34	E-15 34-RR	E-15 34-AA	1.500 x 3/4"	14,20	2,500
E-20 34	E-20 34-RR	E-20 34-AA	2.000 x 3/4"	18,00	1,875

Type NU - 300 microns

Types	Cat. ref. Threaded	Length (mm) x Ø nominal dia (")	Ø Shank dia (mm)	Kg/U
15 NU 146 ②	15 NU 146 RR	1.500 x 16	14,6	2,025
20 NU 146 ②	20 NU 146 RR	2.000 x 16	14,6	2,700
25 NU 146	25 NU 146 RR	2.500 x 16	14,6	3,375
30 NU 146	30 NU 146 RR	3.000 x 16	14,6	4,050
15 NU 183 ②	15 NU 183 RR	1.500 x 20	18,3	3,150
20 NU 183 ②	20 NU 183 RR	2.000 x 20	18,3	4,200
25 NU 183	25 NU 183 RR	2.500 x 20	18,3	5,250
30 NU 183	30 NU 183 RR	3.000 x 20	18,3	6,300

Add "R" if threaded on one end and "RR" if threaded on both ends.

All rod electrodes are supplied in bundles of 5 units.

① Rods certified according to Standard: **UNE 202006:2019**

② Rods certified according to: **UNE 21056:1981/UNE 21056:2000 ERRATUM**

Unthreaded



Self-coupled

Threaded

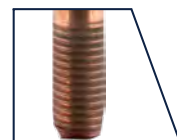

Dimensions indicated are nominal

All our rods are marked on the surface with the **KLK** logo and the corresponding type. Other diameters and/or coating upon request.

Note: Nominal and shank diameters do not correspond as they are threaded by rolling process.



Type J - 250 microns

Types	Cat. ref. Threaded	Length (mm) x Ø Nominal dia (")	Ø Shank Dia. (mm)	Kg/U
J-10 58	J-10 58-RR	1.000 x 5/8"	14,3	1,30
J-15 58	J-15 58-RR	1.500 x 5/8"	14,3	1,95
J-20 58	J-20 58-RR	2.000 x 5/8"	14,3	2,60
J-25 58	J-25 58-RR	2.500 x 5/8"	14,3	3,25
J-30 58	J-30 58-RR	3.000 x 5/8"	14,3	3,90
J-10 34	J-10 34-RR	1.000 x 3/4"	17,3	1,90
J-15 34	J-15 34-RR	1.500 x 3/4"	17,3	2,85
J-20 34	J-20 34-RR	2.000 x 3/4"	17,3	3,80
J-25 34	J-25 34-RR	2.500 x 3/4"	17,3	4,75
J-30 34	J-30 34-RR	3.000 x 3/4"	17,3	5,70

Add "R" if threaded on one end and "RR" if threaded on both ends.
 All rod electrodes are supplied in bundles of 5 units.

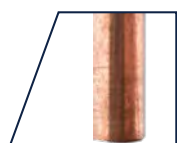

Type CG - 50 microns

Ref.	Length x Ø Nominal Dia. (mm)	Ø Shank Dia. (mm)	Kg/U
10 CG 138	1.000 x 13,8	13,8	1,20
15 CG 138	1.500 x 13,8	13,8	1,80
20 CG 138	2.000 x 13,8	13,8	2,40

Only supplied unthreaded.

Dimensions indicated are nominal

1. Earthing electrodes /

1.1 Earthing rods

Galvanised steel rods

Description Stainless steel rods. The Self-coupling rods have a cone point and perforated head for its self-coupling.

Material **Core:** steel.
Plating: copper.

Type AG - 80 microns

Ref.	Length x Ø Nominal Dia. (mm)	Ø Shank Dia. (mm)	Kg/U
10 AG 160	1.000 x 16	16	1,58
15 AG 160	1.500 x 16	16	2,63
20 AG 160	2.000 x 16	16	3,52



Stainless steel rods

Description Stainless steel rods. The Self-coupling rods have a cone point and perforated head for its self-coupling.

Material Stainless Steel AISI 420-X30Cr13/16 mm.

Type I

Types	Self- extensible	Length x Ø Nominal Dia. (mm)	Ø Shank Dia. (mm)	Kg/U
I-1.016	I-1.016-AA	1.000 x 16	16	1,50
I-1.516	I-1.516-AA	1.500 x 16	16	2,25
I-2.016	I-2.016-AA	2.000 x 16	16	3,00



All the rod electrodes are supplied in bundles of 5 units.

Dimensions indicated are nominal

Zinc rods (cathodic protection)

Description These electrodes have a steel core covered by a thick layer of metallic Zinc and are suitable to be used as sacrificial anodes in cathodic protection systems to reduce the corrosion of structures or buried steel deposits.

Material **Core:** electrogalvanised steel or hot-dip galvanised steel.
Covering: Zinc bath in casting.

All our rods are marked on the surface with the **KLK** logo and the corresponding type. Other diameters and/or coating upon request.

Note: Nominal and shank diameters do not correspond as they are threaded by rolling process.

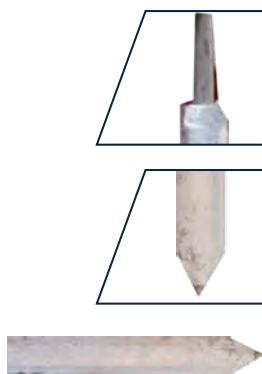

ZN Rods

Ref.	Length x Ø Nominal Dia. (mm)	Ø Rod	Kg/U
10 Zn 30	1.036 x 30	13	5,05
15 Zn 35	1.500 x 35	12	10,17

The lengths and diameters of the steel-zinc rods refer to the zinc coating.

Graphite Electrode

Description High performance electrode for grounding systems. Suitable for terrains with a high corrosion rate, or in extreme temperature conditions.

Materials Graphite.

Graphite electrode

Ref.	Length (mm)	Ø	Kg/U
Graphite electrode	500	50	8



Dimensions indicated are nominal

1. Earthing electrodes /

1.2 Earthing rod accessories

Driving hammer

Description Laminated steel hammer to drive rods of 20 mm maximum diameter.

Material **Head:** round laminated ST-52.
Body: laminated steel pipe of 40x2 mm.
Finish: heat resistant aluminium paint.

MD-10

Ref.	Ø Nominal Dia. Rod size (mm)	Dimensions				Kg/ U
		L (mm)	A (mm)	D (mm)	d (mm)	
MD-10	20	1.150	150	100	40	10



Coupling

Description Auxiliary part which ensures the coupling of the rod section with another to drive the rod deeper.

Material Brass.

Coupling M for Threaded rods

Ref.	Dimensions			Kg/ U
	L (mm)	D (mm)	d (mm)	
M-16	80	23	20,50	0,115
M-58	70	21	18,50	0,115
M-20	70	27	20,00	0,170
M-34	70	24	21,50	0,170



Stud

Description Hexagonal head stud designed to drive threaded rods.

Material Carbon steel.

T

Ref.	T-16	T-58	T-20	T-34
Kg/U	0,09	0,09	0,16	0,16

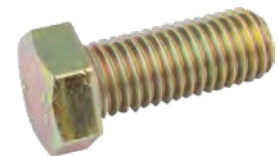

Dimensions indicated are nominal

Driving head

SN



S-AA



Description Auxiliary part to drive rods of 20mm maximum diameter. It ensures the mechanical driving forces are directly transferred without damaging the rod or the coupling.

Material **Body:** round calibrated steel S235 JR.
Finish: bi-chromated.

SN

Ref.	Ø Nominal Dia. rod size (mm)	Dimensions			Kg/ U
		L (mm)	D (mm)	d (mm)	
SN	20	110	30	40	0,41
S-AA	3/4"				0,46

Additive gel

Description It allows to improve the resistivity of the ground. It will be installed in areas of severe pollution, high levels of marine and industrial corrosion and in areas of varying levels of soil resistivity.

Bentonite

Description Material used as filler, ensures contact between the electrode and the ground.

Graphite powder

Description Clay ore used in grounded wells. It allows to absorb moisture. Very used to bury deep electrodes.

Ref.	Kg/U	U
Additive Gel KLK	7	1
Sodium Bentonite	25	1
Graphite powder	25	1

AC-M 150 AL



AC-M 200 FE



Metal earth inspect pits

Description Metal cover to close inspection pits, installed on site, with the earth sign stamped.

Material **AC-M 150 AL** Aluminium foundry.
AC-M 200 FE Iron foundry.

AC-M

Type	A	D	H	Kg/ U
AC-M 150 AL	210	170	50	1,11
AC-M 200 FE	250	200	120	8,00

Dimensions indicated are nominal

1. Earthing electrodes /
 1.2 Earthing rod accessories

Polyester earth inspection pits

Description Bottomless earth inspection pits. Made in polyester, with earthing sign stamped.

Material Polyester resin reinforced with fibreglass.

AC-CP (round), AC-RP (square)

Type	D (mm)	A (mm)	H (mm)	Thickness (mm)	Kg/U
AC - CP 20	200	285	500	2-3	1,40
AC - CP 30	300	400	520	2-3	2,40
AC - RP 40	450	450	490	>2,5	2,90



AC-CP



AC-RP

Polyester rectangular pit

Description Polyester rectangular pit. This pit is closed with bottom and with punched holes. Cover with earthing sign stamped.

Material Polyester resin reinforced with fibreglass.

AC - RP 60

Type	A (mm)	D (mm)	H (mm)	Thickness (mm)	Kg/U
AC - RP 60	460	685	280	3	6



PVC rectangular pit

Description Siphon pit, accessible with cover and passable.

Material PVC.

AC - RP

Type	A (mm)	D (mm)	H (mm)	Kg/U
AC - RP 200	200	200	200	1,2
AC - RP 300	300	300	300	1,5
AC - RP 400	400	400	400	1,7



Dimensions indicated are nominal

Earthing rod clamps

Description **KR and KR-30:** single-wire clamp for Cable/Rod connection formed by one hot-stamping body and tightening with hexagonal stud.

KU: single-wire clamp for Cable/Rod connection formed by two hot-stamping bodies and with U-bolt tightening.

KB: Two-wire clamp for Cable/Rod connection formed by two hot-stamped bodies and one U-bolt tightening.

Material **Body:** copper-rich alloy (Brass).

Hardware: stainless steel.

 KR-1
 KR-2

KR-30

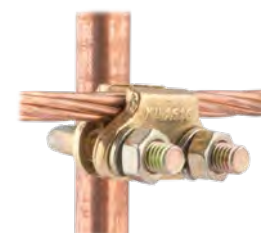

KR and KR-30

Ref.	Ø Máx. Rod size (mm)	Conductor range		T	Kg/U
		Strand (mm ²)	Ø Wire (mm)		
KR-1	16	10-70	4-11	M 8	0,06
KR-2	20	25-95	6-13	M 10	0,11
KR-30	20	Bus-Bar from 30 x 1 to 30 x 10		M 10	0,12

KU

Ref.	Ø Máx. Rod size (mm)	Conductor range		T	Kg/U
		Strand (mm ²)	Ø Wire (mm)		
KU-1616*	15	16-35	4-6	M 8	0,10
KU-1625	16	25-70	6-11	M 10	0,25
KU-2025	20	25-70	6-11	M 10	0,25
KU-1663	20	70-95	10-13	M 10	0,25
KU-2012	20	95-185	10-18	M 10	0,42

* Electroplated steel hardware

KB

Ref.	Ø Máx. Rod size (mm)	Conductor range		T	Kg/U
		Strand (mm ²)	Ø Wire (mm)		
KB-1625	16-20	25-70	6-11	M 10	0,25
KB-1663	16-20	70-95	10-13	M 10	0,25
KB-2012	20	95-185	13-18	M 10	0,53

Rod terminal

Description Cross earth terminal for cable, re-bar or bus bar with rod connection.

Material Galvanised steel.



RAC-20/30X3,5

Ref.	Ø Máx. Rod size (mm)	Conductor range			Kg/U
		Strand (mm ²)	Ø Wire (mm)	Max. Plate size (mm)	
RAC-20/30x3,5	16-20	25-70	7-10	40 x 5	0,06

Dimensions indicated are nominal

1. Électrodes de mise à la terre /

1.4 Plate and crowfoot

Earthing grids

Description Cooper earthing grids with or without solid band.

Material **Body:** copper.

Ref.	Dimensions		Section	Mesh (mm)	Kg/U	U
	A	B				
GTC-10/10/2	1.000	1.000	2 x 2	115 x 55	2,00	1
GTC-10/10/3	1.000	1.000	3 x 3	115 x 55	4,00	1
GTC-20/10/2	2.000	1.000	2 x 2	115 x 55	4,00	1
GTC-20/10/3	2.000	1.000	3 x 3	115 x 55	8,00	1
GTC-10/10/2 SB	1.000	1.000	2 x 2	115 x 55	1,15	1
GTC-10/10/3 SB	1.000	1.000	3 x 3	115 x 55	3,20	1
GTC-20/10/2 SB	2.000	1.000	2 x 2	115 x 55	2,30	1
GTC-20/10/3 SB	2.000	1.000	3 x 3	115 x 55	6,50	1

Other dimensions upon request.

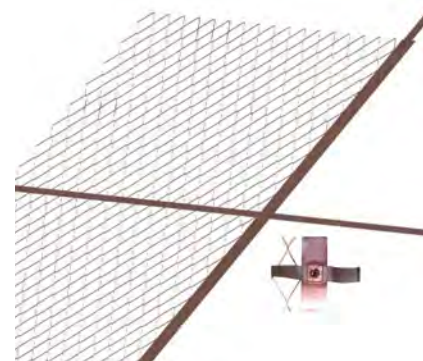

Earth mesh

Description Copper grid with or without solid band. Welded by aluminothermal welding.

Material **Body:** copper.

Ref.	Dimensions		Section	Mesh (mm)	Kg/U	U
	A	B				
GTC-20/10/2 ALU*X	2.000	1.000	2 x 2	115 x 55	-	1
GTC-20/10/3 ALU*X	2.000	1.000	3 x 3	115 x 55	-	1

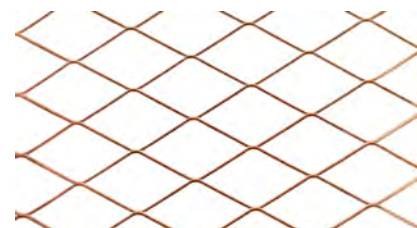

PO - 3XX/1XY

Description Crowfoot recommended to achieve a low inductance on the earthing.

Material Tinned copper.

X: length of the branched conductors.

Y: length of the main conductor.

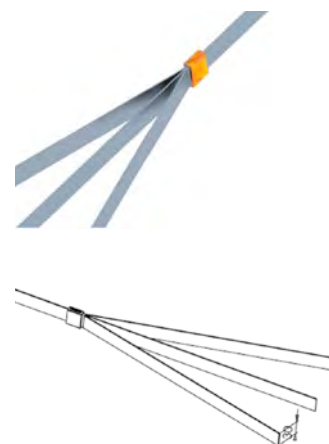

Dimensions indicated are nominal

Miscellaneous clamps

Description	KBL: two-wire staple formed by two hot stamped bodies. Cable tightening is done using a hexagonal screw.
	KBH: two-wire staple formed by two hot stamped bodies. Cable tightening is done using two hexagonal screws.
	KDP: two-wire staple formed by two hot stamped bodies. Cable tightening is done using a hexagonal screw.

Material	Body: copper-rich alloy (Brass).
	Hardware: stainless steel.



KBL				
Ref.	Conductor range		T	Kg/U
	Strand (mm ²)	Ø Wire (mm)		
KBL-25	25-70	6-11	M 8 x 35	0,20
KBL-63	70-95	11-13	M 10 x 45	0,22
KBL-125	95-185	12-18	M 10 x 55	0,51



KBH				
Ref.	Conductor range		T	Kg/U
	Strand (mm ²)	Ø Wire (mm)		
KBH-25	25-70	6-11	M 8 x 35	0,22
KBH-63	70-95	11-13	M 10 x 45	0,26
KBH-125	95-185	13-18	M 10 x 55	0,54



KDP				
Ref.	Conductor range		T	Kg/U
	Strand (mm ²)	Ø Wire (mm)		
KDP-10/35	4-30	2-6	2 x M 6	0,027
KDP-10/50	10-50	4-9	M 6	0,040
KDP-10/50/2	10-50	4-9	2 x M 6	0,070
KDP-16/95/2	16-95	4-13	2 x M 6	0,095
KDP-25/150	25-150	6-16	2 x M 8	0,198
KDP-50	16-50	4-9	M 8 x 30	0,070
KDP-95	25-95	6-13	M 8 x 35	0,118
KDP-150	35-150	7-16	M 10 x 40	0,175
KDP-240	95-240	12-20	2-M 8 x 60	0,350

Dimensions indicated are nominal

2. Connection for round and flat conductor /

2.1 Connectors

Miscellaneous clamps

Description	KZ: two-cable cross clamp branch formed by three hot-stamped bodies and with hardware tightening.
	KM: single-piece clamp for fixing cable to metal structure formed by a hot stamped body. Cable tightening and fixing to the structure is done using a hexagonal screw. It cannot be mounted on concrete, since the screw head is embedded in the clip and does not allow rotation to screw it into the plug inserted into the concrete.
	KML: two-wire clamp to fix two cables to a metal or concrete structure formed by one hot-stamped body. The tightening is with one hexagonal screw.

Material	Body: copper-rich alloy (Brass). Hardware: stainless steel.
-----------------	--

KZ				
Ref.	Conductor range		T	Kg/U
	Strand (mm ²)	Ø Wire (mm)		
KZ-25	25-70	6-11	M 8	0,240
KZ-63	70-95	10-13	M 10	0,835
KZ-100	95-185	12-18	M 10	0,835



KM				
Ref.	Conductor range		T	Kg/U
	Strand (mm ²)	Ø Wire (mm)		
KM-25	25-70	6-11	M 8 x 30	0,05
KM-63	70-95	10-13	M 10 x 35	0,11
KM-100	95-185	12-18	M 10 x 50	0,16



KML				
Ref.	Conductor range		T	Kg/U
	Strand (mm ²)	Ø Wire (mm)		
KML-25	25-70	6-11	M 8 x 35	0,14
KML-63	70-95	10-13	M 12 x 35	0,14
KML-125	95-185	12-18	M 10 x 55	0,29



Dimensions indicated are nominal

Miscellaneous clamps (stamped brass)

Description Corrosion resistant high strength copper alloy body.

Material **Body:** copper-rich alloy (Brass).
Hardware: stainless steel.



STN. Earth connector for two parallel cables

Ref.	Admissible Drivers		T M	Kg/U	U
	Cable mm ²	Ø Wire (mm)			
STN-120	50-120	8-13	M 12 x 60 A2	0,25	5
STN-150	120-240	13-20	M 14 x 70 A2	0,35	5
STN-185	185-240	18-20	M 14 x 80 A2	0,43	5



STND. Double earth connector for two parallel cables

Ref.	Admissible Drivers		T M	Kg/U	U
	Cable mm ²	Ø Wire (mm)			
STN-120	50-120	8-13	M 12 x 80 A2	0,34	5
STN-150	120-240	13-20	M 14 x 90 A2	0,50	5
STN-185	185-240	18-20	M 14 x 100 A2	0,60	5



STA. Two-wing ground connector

Ref.	Admissible Drivers		T M	Kg/U	U
	Cable mm ²	Ø Wire (mm)			
STA 2-120	50-120	8-13	M 12 x 60 A2	0,60	25
STA 2-150	120-240	13-20	M 14 x 70 A2	0,80	25
STA 2-185	185-240	18-20	M 14 x 80 A2	0,91	25



STDA Double Wing Ground Connector

Ref.	Admissible Drivers		T M	Kg/U	U
	Cable mm ²	Ø Wire (mm)			
STDA 2-120	50-120	8-13	M 12 x 80 A2	0,70	25
STDA 2-150	120-240	13-20	M 14 x 90 A2	0,90	25
STDA 2-185	185-240	18-20	M 14 x 100 A2	1,05	25

Dimensions indicated are nominal

2. Connection for round and flat conductor /

2.1 Connectors

Terminals and connectors

Description **TK.P:** terminal for cable, formed by a round body and one flat blade. The tightening of the cables is with hold-down nut.
TK.T: terminal for cable, formed by one round body and one flat blade. The tightening of the cable is with hexagonal bolt.

Material **Body and screw:** copper-rich alloy (Brass).
Hardware: stainless steel.

TK.P and TK.T

Ref.	Section Conductor Strand (mm ²)		Ø Screw Hole Dia. Ø (mm)	E mm	Kg/U
	Min.	Máx.			
TK 25 P	10	25	6,5	3	0,025
TK 50 P	25	50	8,5	4	0,060
TK 150 P	50	150	10,5	5	0,125
TK 300 P	95	300	12,5	7	0,340
TK 25 T	10	25	6,5	3	0,025
TK 50 T	25	50	8,5	4	0,060
TK 150 T	50	150	10,5	5	0,125
TK 300 T	95	300	12,5	7	0,340

TK.P



TK.T



Raccords a serrage par bride

Description **CD:** copper alloy body with high mechanical resistance, manufactured by hot-stamping and corrosion resistant.
CT: copper alloy body with high mechanical resistance, manufactured by hot-stamping and corrosion resistant.

Material **Body:** copper-rich alloy (Brass).
Boulonnerie: electrogalvanised steel.

CD and CT

Ref.	Conductor range		T	Ø mm	Kg/100	U
	Strand (mm ²)	Ø Wire (mm)				
CD-10/70-8	10-70	3-11	M 5	8	7,20	25
CD-10/70-10	10-70	3-11	M 5	10	7,20	25
CD-10/70-12	10-70	3-11	M 5	12	7,20	25
CD-25/120-12	25-120	6-15	M 8	12	13,20	25
CT-10/70-8	10-70	3-11	M 5	8	8,00	25
CT-10/70-10	10-70	3-11	M 8	10	8,00	25
CT-25/120-12	25-120	6-15	M 8	12	18,00	25



Dimensions indicated are nominal

Tightening connector

Description Copper alloy body with high mechanical resistance, manufactured by hot-stamping and corrosion resistance.

RD: linear connection.

RT: T connection.

CE: angular connection

Material **Body:** copper-rich alloy (Brass).
Hardware: electrogalvanized steel



RD					
Ref.	Conductor range		T	Kg/100	U
	Strand (mm ²)	Ø Wire (mm)			
RD-10/70	10-70	3-11	M 6	10	25
RD-25/120	25-120	6-15	M 8	13	25



RT					
Ref.	Conductor range		T	Kg/100	U
	Strand (mm ²)	Ø Wire (mm)			
RT-10/70	10-70	4-11	M 6	10,5	25
RT-25/120	25-150	6-16	M 8	20,0	10



CE						
Ref.	Conductor range		T	Ø mm	Kg/100	U
	Strand (mm ²)	Ø Wire (mm)				
CE-10/70-8	10-70	4-11	M 8	08	7,60	25
CE-25/120/12	25-120	6-15	M 12	12	7,20	25

Dimensions indicated are nominal

2. Connection for round and flat conductor /

2.1 Connectors

Connector in C (copper)

Description C compression connector.

Material Copper.

Ref.	Main conductor Cu (mm ²)		Tap conductor Cu (mm ²)		U
	Multi thread Min. (mm ²)	Multi thread Max. (mm ²)	Multi thread Min. (mm ²)	Multi thread Max. (mm ²)	
C6	2,5	6	1,5	6	300
C10	10	10	1,5	10	150
C25D10	10	25	2,5	10	50
C25D16	10	25	2,5	16	50
C25D25	10	25	10	25	50
C40D35	35	40	10	35	50
C40D40	35	40	35	40	50
C50	50	50	50	50	25
C70D35	50	70	10	35	25
C70	50	70	50	70	25
C100D35	95	100	10	35	25
C100D70	95	100	40	70	25
C100	95	100	95	100	25
C125	100	125	25	125	10
C185D100	150	185	25	100	10
C150	150	150	70	150	10
C185	120	185	95	185	10



Dimensions indicated are nominal

Cross connections

Description	<p>RC-30 HEX and RCBE-30: copper wire and/or bus-bar connection clamp.</p> <p>RCRE-30: copper alloy body with high mechanical resistance and corrosion resistant, bus-bar / bus-bar connection clamp.</p> <p>RCG-30/RCG-30 THREADED: copper wire and bus-bar connection clamp.</p>
Material	<p>Material: RC-30 HEX Copper, RCBE-30 Tinned copper</p> <p>Hardware: stainless steel.</p> <p>RCRE-30. Body: tinned copper. Hardware: stainless steel.</p> <p>RCG-30/RCG-30 THREADED. Body and hardware: galvanised steel.</p>

RC-30 HEX
Red copper.



RCBE-30
Tinned copper.

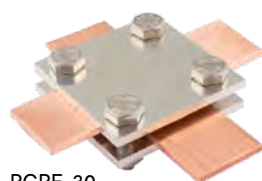

RCRE-30
Tinned copper.



RCG-30
Galvanized steel.

RC-30 HEX and RCBE-30

Ref.	Dimensions			Hardware	Capacity (mm)	Kg/U	U
	A	B	e				
RC-30 HEX	50	50	2,5	4 x M 6 x 20	Ø6-10/6-10 mm 6-10/30 mm 30/30 mm	0,15	50
RCBE-30	50	50	2,5	4 x M 6 x 20	Ø6-10/6-10 mm 6-10/30 mm 30/30 mm	0,15	50

RCRE-30

Ref.	Dimensions			Hardware	Capacity (mm)	Kg/U	U
	A	B	e				
RCRE-30	60	60	4	4 x M 8 x 25	30 x 4 mm	0,30	25

RCG-30 and RCG-30 threaded

Ref.	Dimensions			Hardware	Capacity (mm)	Kg/U	U
	A	B	e				
RCG-30 RCG-30 R	60	60	3	4 x M 8 x 25	Ø8-10 / 8-10 mm 8-10 / 30 mm 30 / 30 mm	0,25	50

Dimensions indicated are nominal

2. Connection for round and flat conductor /

2.2 Cross, splice and earthing connectors

Cross connections

Description **RC-1x:** connection clamp for cross conductors.
RCR-301x: bus-bar / bus-bar connection clamp.
RCR-301x/S: copper wire and bus-bar connection clamp.

Material **RC-1x y RCR-301x:** stainless steel.
RCR-301x/S: stainless steel.

RC-1x

Ref.	Dimensions (mm)			Hardware	Capacity (mm)	Kg/U	U
	A	B	e				
RC-1x	55	55	1	4 x M 6 x 16	Ø8-10 mm 30 x 2 mm	0,15	50



RCR-301X and RCR-301X/S

Ref.	Dimensions (mm)			Hardware	Capacity (mm)	Kg/U	U
	A	B	e				
RCR-301x	60	60	3	4 x M 8 x 25	Ø8-10 mm/30 mm 30 mm/30 mm	0,250	25
RCR-301x/s	60	60	3	4 x M 8 x 25	Ø8-10/16 mm 16 mm/30 mm 50 mm ² -70 mm ² /120 mm ²	0,319	25



Dimensions indicated are nominal

Cross connection

Description Connection terminal formed by two pieces, with hexagonal stud and thread on the bottom part.

Material Galvanised steel.



RAC 8-10 and RAC 8-10/16

Ref.	Dimensions (mm)			Hardware	Capacity (mm)	Kg/U	U
	A	B	e				
RAC 8-10	40	40	2,5	M 10 x 30	8-10	0,10	50
RAC 8-10/16	48	44	2,5-3	M 10 x 40	8-10/16	0,12	50

Terminal

Description Multiple-use connection terminal, with cross terminal, T and parallel terminal of three pieces, with thread on the bottom part.

Material Galvanised steel.



RAG-30

Ref.	Capacity Ø (mm)	Kg	U
RAG-30	8-16/15-25	0,480	20

Terminal

Description Clamp for reinforcement bar and bus-bar with stud M 10x40.

Material Galvanised steel.



RPP-30

Ref.	Capacity Ø (mm)	Kg	U
RPP-30	6-22/30-40 mm	0,125	25

Terminal

Description Terminal for round and flat conductors.

Material Galvanised steel.



RDG-30

Ref.	Capacity Ø (mm)	Kg	U
RDG-30	7-10/7-10, 7-10/30, 30/30	0,25	25

Dimensions indicated are nominal

2. Connection for round and flat conductor /

2.2 Cross, splice and earthing connectors

Fixed earthing points

Description Stainless steel earthing terminal with 80 diameter head and threaded hole M 10/12/16 supplied with plastic protective cover.

Material **Exterior plate:** acier Inoxydable.
Rod: hot-galvanised steel.

PT- M10/ M12 and PT- M16

Ref.	Rod Ø (mm)	Kg/U	U
PT-M 10 / M 12	10 x 200	0,300	5
PT-M 16	10 x 400	0,603	5



Fixed earthing points

Description Equipotential point fixed to the structure to provide fixing points for the earthing.

Material **Body:** bronze.
Hardware: brass, 2xM10x25.

EP2P

Ref.	Rod Ø (mm)	Dimensions (mm)	Capacity (mm)	Kg/U	U
EP2P	10 x 50	52 x 52	25 x 3/Ø8-10	0,44	5



Connection clamp

Description Connection clamp for cable / bus-bar.

Material **Body:** hot-galvanised steel.
Hardware: stainless steel.

RAC - 8/30X3,5

Ref.	Dimensions			Hardware	Capacity (mm)	Kg/U	U
	A	B	e				
RAC-8/30 X 3,5	58	30	2.5	2 x M 8 x 20	Ø8-Ø10/Ø8-Ø10 Ø8-Ø10/30	0,25	25



Anti-corrosion tape

Description Tape to protect the buried connections from corrosion.

Material Petrolatum.

RUBDENSO

Ref.	Dimensions (Length x width)	Kg	U
RUBDENSO	Roll of tape 10 m x 50 mm	0,75	1



Dimensions indicated are nominal

Miscellaneous clamps

Description **GK:** two-wire clamp, formed by one machining hexagonal body. Tightening of the cables is with hold-down nut.

KX and KXP: single-wire clamp to support cable to metal structure, formed by one machining hexagonal body. The cable is tightened with a hold-down nut.

KXR: single-cable clamp to support cable to metal structure, formed by a mechanised round body. The cable is tightened with stay bolt.

Cable tightening is done by bolt.

Material **Body, nut, hold-down nut and bolt:** copper rich allow (Brass).



GK				
Ref.	Conductors Rang		T	Kg/U
	Strand (mm ²)	Ø Wire (mm)		
GK-35	16-35	5,5-6,5	M 14	0,035
GK-63	35-70	7-9,5	M 20	0,070
GK-120	50-120	9-14	M 27	0,180



KX				
Ref.	Conductors Rang		T	Kg/U
	Strand (mm ²)	Ø Wire (mm)		
KX-10	10-35	4-08	M 8 x 20	0,05
KX-25	25-70	6-11	M 10 x 25	0,01
KX-63	70-95	10-13	M 12 x 25	0,19
KX-100	95-185	12-18	M 14 x 25	0,34



KXP				
Ref.	Conductors Rang		T	Kg/U
	Strand (mm ²)	Ø Wire (mm)		
KXP-10	10-35	4-08	M 6 x 7	0,035
KXP-25	25-70	6-11	M 6 x 11	0,080
KXP-63	70-95	10-13	M 8 x 13	0,165
KXP-100	95-185	12-18	M 10 x 15	0,300



KXR				
Ref.	Conductors Rang		T	Kg/U
	Strand (mm ²)	Ø Wire (mm)		
KXR-10	10-035	4-08	M 6 x 6	0,030
KXR-25	25-70	6-11	M 6 x 6	0,055
KXR-63	70-95	10-13	M 8 x 10	0,105
KXR-100	95-185	12-18	M 8 x 10	0,145

Dimensions indicated are nominal

3. Fixing accessories for flat and round conductors /

3.1 Tightening clamps, washers and supports

Supports

Description Wedge bolt for fixing on fl at or sloping surface.
It has a smooth hole to insert a threaded rod.

Material Cast iron.

TKM				
Ref.	M / Ø	H	Resistance (kg)	U
TKM 1000	M 6	18	120	50
TKM 1005	Ø 9	18	120	50
TKM 1010	M 8	18	120	50
TKM 1015	Ø 11	20	250	50
TKM 1020	M 10	20	250	50
TKM 1025	Ø 13	26	350	50
TKM 1030	M 12	26	350	50
TKM 1035	M 16	28	550	50



Connector (1 of 2)

Description Copper-rich alloy body of high mechanical resistance and resistant to corrosion.

Material Body: copper-rich allow (Brass).

HKXR						
Ref.	A		B	C	Kg/100	U
	S (mm ²)	Ø (mm)	Min (mm)	C1 (mm)		
HKXR-25/6	25	3-6	17	M 6	2,40	50
HKXR-35/6	35	4-8	19	M 6	3,10	50
HKXR-50/6	50	7-10	21	M 6	4,65	50
HKXR-95/6	95	8-12	24	M 6	6,71	25
HKXR-120/6	120	10-14	26	M 6	8,80	25
HKXR-150/6	150	10-16	30	M 6	14,00	10
HKXR-185/6	185	16-18	32	M 6	16,20	10
HKXR-240/6	240	18-20	36	M 6	22,50	10
HKXR-25/7	25	3-6	17	M 7	2,40	50
HKXR-35/7	35	4-8	19	M 7	3,10	50
HKXR-60/7	60	7-10	21	M 7	4,65	50
HKXR-95/7	95	8-12	24	M 7	6,71	25
HKXR-120/7	120	10-14	26	M 7	8,80	25
HKXR-150/7	150	10-16	30	M 7	14,00	10
HKXR-185/7	185	16-18	32	M 7	16,20	10
HKXR-240/7	240	18-20	36	M 7	22,50	10
HKXR-25/8	25	3-6	17	M 8	1,80	50
HKXR-35/8	35	4-8	19	M 8	3,00	50

HKXR

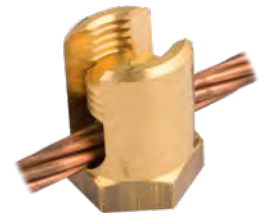

Dimensions indicated are nominal

3. Fixing accessories for flat and round conductors / 3.1 Tightening clamps, washers and supports

Connector (2 of 2)

HKXR....BM



HKXR						
Ref.	A		B	C	Kg/100	U
	S (mm ²)	Ø (mm)	Min (mm)	C1 (mm)		
HKXR-60/8	60	6-10	21	M 8	4,80	50
HKXR-95/8	95	8-12	24	M 8	7,00	25
HKXR-120/8	120	10-14	26	M 8	8,90	25
HKXR-150/8	150	10-16	30	M 8	14,00	10
HKXR-185/8	185	16-18	32	M 8	16,20	10
HKXR-240/8	240	18-20	36	M 8	22,50	10
HKXR-95/6 BM	95	8-12		M 6x-21	0,09*	
HKXR-120/8 BM	120	10-14		M 8x-22	0,11*	
HKXR-150/8 BM	150	10-16		M 8x-22	0,17*	
HKXR-185/8 BM	185	16-18		M 8x-22	0,20*	

Bi-metallic washers

Description Bi-metallic washer, used for connections between copper conductors and aluminium conductors to prevent galvanic corrosions which make the connection inefficient and unreliable.

Material Cuivre-Aluminium.

BM-30



BM					
Ref.	A (Ø mm)	B1 x B2 (mm)	Ø (mm)	Kg/100	U
BM-30/2/6,5	30 x 2 thickness		6,5	0,46	100
BM-30/2/8,5	30 x 2 thickness		8,5	0,45	100
BM-30/2/10,5	30 x 2 thickness		10,5	0,45	100
BM-30/2/13	30 x 2 thickness		13,0	0,45	100
BM-30/2/14,3	30 x 2 thickness		14,5	0,45	100
BM-55/36/1/16,5	Rectangular	55 x 36 x 1	16,5	1,30	100

Fixing elements

Description Fixing elements.

Material Hardware: galvanised steel. Dowel: nylon.

PAV



CH-V

PAV / CH-V				
Ref.	L (mm)	Hardware	C (Ø: mm)	U
PAV-6 x 100		6 x 1		
PAV-7 x 150	40	7 x 1,50		100
PAV-8 x 125	50	8 x 1,25		100
PAV-10 x 150	60	10 x 1,50		100
CH-V 7			7	100
CH-V 8	40		8	100
CH-V 10	45		10	100

Dimensions indicated are nominal

3. Fixing accessories for flat and round conductors /

3.2 Terminals

Compression cable lugs (1 of 2)

Description Bell butt compression cable lug. Includes hole to verify the right placing of the cable.

Material Tinned copper. Standard NFC 20-130.



CTUD										
	Ref.	A		B			C		Kg/100	U
		S (mm ²)	Ø (mm)	B1 (mm)	B2 (mm)	B3 (mm)	M	Ø (mm)		
4 ²	CTU-4/6	4	2,7	5,0	12	19	M 6	4,3	0,24	100
	CTU-4/8	4	2,7	5,0	12	22	M 8	6,5	0,31	100
6 ²	CTU-6/4	6	3,3	5,5	13	24	M 4	4,3	0,36	100
	CTU-6/6	6	3,3	5,5	13	25	M 6	6,5	0,36	100
	CTU-6/8	6	3,3	5,5	13	28	M 8	8,5	0,42	100
10 ²	CTU-10/6	10	4,2	6,8	12	27	M 6	6,5	0,49	100
	CTU-10/8	10	4,2	6,8	15	29	M 8	8,5	0,60	100
	CTU-10/10	10	4,2	6,8	16	31	M 10	10,5	0,72	100
	CTU-10/12	10	4,2	6,8	19	32	M 12	13,0	0,66	100
16 ²	CTU-16/6	16	5,5	8,0	12	30	M 6	6,5	0,68	100
	CTU-16/8	16	5,5	8,0	16	32	M 8	8,5	0,77	100
	CTU-16/10	16	5,5	8,0	16	34	M 10	10,5	0,79	100
	CTU-16/12	16	5,5	8,0	19	35	M 12	13,0	0,80	100
25 ²	CTU-25/6	25	6,6	9,5	13	32	M 6	6,5	1,05	100
	CTU-25/8	25	6,6	9,5	16	34	M 8	8,5	1,24	100
	CTU-25/10	25	6,6	9,5	17	37	M 10	10,5	1,33	100
	CTU-25/12	25	6,6	9,5	19	38	M 12	13,0	1,30	100
35 ²	CTU-35/6	35	7,9	11,0	15	37	M 6	6,5	1,33	100
	CTU-35/8	35	7,9	11,0	17	40	M 8	8,5	1,45	100
	CTU-35/10	35	7,9	11,0	17	41	M 10	10,5	1,60	100
	CTU-35/12	35	7,9	11,0	19	45	M 12	13,0	1,65	100
50 ²	CTU-50/8	50	9,2	12,5	18	41	M 8	8,5	1,95	100
	CTU-50/10	50	9,2	12,5	18	43	M 10	10,5	2,20	100
	CTU-50/12	50	9,2	12,5	19	45	M 12	13,0	2,31	100
	CTU-50/16	50	9,2	12,5	26	50	M 16	17,0	2,50	100
70 ²	CTU-70/8	70	11,0	15,0	21	55	M 8	8,5	3,18	100
	CTU-70/10	70	11,0	15,0	21	55	M 10	10,5	3,38	100
	CTU-70/12	70	11,0	15,0	22	55	M 12	13,0	3,58	100
	CTU-70/16	70	11,0	15,0	28	55	M 16	16,0	3,85	100
95 ²	CTU-95/8	95	13,1	17,0	25	46	M 8	8,5	4,25	50
	CTU-95/10	95	13,1	17,0	25	48	M 10	10,5	4,45	50
	CTU-95/12	95	13,1	17,0	25	50	M 12	13,0	4,65	50
	CTU-95/16	95	13,1	17,0	25	54	M 16	17,0	5,85	50

Dimensions indicated are nominal

Compression cable lugs (2 of 2)



CTUD										
	Ref.	A		B			C		Kg/100	U
		S (mm ²)	Ø (mm)	B1 (mm)	B2 (mm)	B3 (mm)	M	Ø (mm)		
120 ²	CTU-120/10	120	14,5	19	28	52	M 10	10,5	5,90	50
	CTU-120/12	120	14,5	19	28	53	M 12	13,0	6,10	50
	CTU-120/16	120	14,5	19	28	56	M 16	17,0	6,60	50
150 ²	CTU-150/12	150	16,2	21	30	58	M 12	13,0	8,45	50
185 ²	CTU-185/12	185	18,0	23	34	65	M 12	13,0	11,20	50
	CTU-185/16	185	18,0	23	34	68	M 16	17,0	10,00	50
	CTU-185/20	185	18,0	23	40	70	M 20	21,0	11,40	50
240 ²	CTU-240/12	240	20,6	26	39	72	M 12	13,0	15,00	25
	CTU-240/16	240	20,6	26	39	72	M 16	17,0	14,60	25
	CTU-240/20	240	20,6	26	39	72	M 20	21,0	14,20	25
300 ²	CTU-300/12	300	23,1	28	41	80	M 12	13,0	15,25	20
	CTU-300/16	300	23,1	28	41	83	M 16	17,0	16,20	20
	CTU-300/20	300	23,1	28	41	85	M20	21,0	16,95	20
400 ²	CTU-400/12	400	26,1	32	47	96	M 12	13,0	26,80	20
	CTU-400/16	400	26,1	32	47	96	M 16	17,0	25,60	20
	CTU-400/20	400	26,1	32	47	96	M 20	21,0	26,10	20

Compression cable lugs (1 of 2)

Description Compression cable lug.

Material Tinned Copper Standard DIN 46-235.



CTUD									
	Ref.	A	B			C		Kg/100	U
		S (mm ²)	B1 (mm)	B2 (mm)	B3 (mm)	M	Ø (mm)		
16 ²	CTUD-16/6	16	8,5	13	36	6	6,4	1,19	100
	CTUD-16/8	16	8,5	13	36	8	8,4	1,22	100
	CTUD-16/10	16	8,5	17	36	10	10,5	1,30	100
	CTUD-16/12	16	8,5	18	36	12	13,0	1,27	100
25 ²	CTUD-25/6	25	10,0	14	38	6	6,4	1,51	100
	CTUD-25/8	25	10,0	16	38	8	8,4	1,54	100
	CTUD-25/10	25	10,0	17	38	10	10,5	1,62	100
	CTUD-25/12	25	10,0	19	38	12	13,0	1,66	100

Dimensions indicated are nominal

3. Fixing accessories for flat and round conductors /

3.2 Terminals

Compression cable lugs (2/2)

CTUD									
	Ref.	A	B			C		Kg/100	U
		S (mm ²)	B1 (mm)	B2 (mm)	B3 (mm)	M	Ø (mm)		
35 ²	CTUD-35/6	35	12,5	17	42	M 6	6,4	2,77	100
	CTUD-35/8	35	12,5	17	42	M 8	8,4	2,85	100
	CTUD-35/10	35	12,5	19	42	M 10	10,5	2,84	100
	CTUD-35/12	35	12,5	21	42	M 12	13,0	2,79	100
50 ²	CTUD-50/8	50	14,5	20	52	M 8	8,4	4,46	50
	CTUD-50/10	50	14,5	22	52	M 10	10,5	4,48	50
	CTUD-50/12	50	14,5	24	52	M 12	13,0	4,40	50
	CTUD-50/16	50	14,5	28	52	M 16	17,0	4,57	50
70 ²	CTUD-70/8	70	16,5	24	55	M 8	8,4	5,92	50
	CTUD-70/10	70	16,5	24	55	M 10	10,5	6,02	50
	CTUD-70/12	70	16,5	24	55	M 12	13,0	5,89	50
	CTUD-70/16	70	16,5	30	55	M 16	17,0	6,13	50
95 ²	CTUD-95/8	95	19,0	28	65	M 8	8,5	9,21	50
	CTUD-95/10	95	19,0	28	65	M 10	10,5	8,97	50
	CTUD-95/12	95	19,0	28	65	M 12	13,0	8,62	50
	CTUD-95/16	95	19,0	32	65	M 16	17,0	9,00	50
120 ²	CTUD-120/10	120	21,0	32	70	M 10	10,5	11,40	50
	CTUD-120/12	120	21,0	32	70	M 12	13,0	11,31	50
	CTUD-120/16	120	21,0	32	70	M 16	17,0	11,34	50
	CTUD-120/20	120	21,0	38	70	M 20	21,0	11,03	50
150 ²	CTUD-150/10	150	23,5	34	78	M 10	10,5	16,38	50
	CTUD-150/12	150	23,5	34	78	M 12	13,0	16,29	50
	CTUD-150/16	150	23,5	34	78	M 16	17,0	16,17	50
	CTUD-150/20	150	23,5	40	78	M 20	21,0	15,90	50
185 ²	CTUD-185/10	185	25,5	37	82	M 10	10,5	18,96	25
	CTUD-185/12	185	25,5	37	82	M 12	13,0	18,11	25
	CTUD-185/16	185	25,5	37	82	M 16	17,0	18,74	25
	CTUD-185/20	185	25,5	40	82	M 20	21,0	18,69	25
240 ²	CTUD-240/12	240	29,0	42	92	M 12	13,0	27,00	25
	CTUD-240/16	240	29,0	42	92	M 16	17,0	27,37	25
	CTUD-240/20	240	29,0	45	92	M 20	21,0	26,88	25
300 ²	CTUD-300/16	300	32,0	46	100	M 16	17,0	32,94	20
	CTUD-300/20	300	32,0	46	100	M 20	21,0	33,24	20
400 ²	CTUD-400/16	400	38,5	54	115	M 16	17,0	68,54	10
	CTUD-400/20	400	38,5	54	115	M 20	21,0	65,40	10
500 ²	CTUD-500/16	500	42,0	60	125	M 16	17,0	83,31	10
	CTUD-500/20	500	42,0	60	125	M 20	21,0	81,58	10



Dimensions indicated are nominal

3. Fixing accessories for flat and round conductors / 3.3 Vertical and horizontal fixings

Fixing elements



Description Insulating plastic support for bus-bar or round conductor, UV resistant.

Material **Body:** nylon.
Hardware: stainless steel.

SP 30 IX

Ref.	Fixing hole mm	Capacity	Kg/100 U	U
SP-30 IX	5 x 10	Ø 6 - Ø 8 30 x 2 - 30 x 4	2,5	100

SP-30CH



Fixing elements

Description Insulating plastic support for bus-bar or round conductor, UV resistant.

Material **Body:** nylon.
Hardware: stainless steel.

SP-30 CH and SP-30 M

Ref.	M	Capacity	Kg/100 U	U
SP-30 CH8	M 6	Ø 6 - Ø 8 30 x 2 - 30 x 4	2,20	50
SP-30 M6	M 6	Ø 6 - Ø 8 30 x 2 - 30 x 4	2,20	50
SP-30 M8	M 8	Ø 6 - Ø 8 30 x 2 - 30 x 4	2,20	50

SP-30 M



Plastic support

Description Insulating plastic support, UV resistant for fixing cable or bus-bar.

Material **Body:** nylon.
Hardware: stainless steel.



SP - ... / CH and SP - ... / M

Ref.	M	mm	Capacity	Kg/100 U	U
SP-13 CH8		Ø 8 x 40	Ø 13	2,2	50
SP-13 M6	M 6		Ø 13	2,2	50
SP-13 M8	M 8		Ø 13	2,2	50
SP-16 CH8		Ø 8 x 40	Ø 16	2,2	50
SP-16 M6	M 6		Ø 16	2,2	50
SP-16 M8	M 8		Ø 16	2,2	50

Dimensions indicated are nominal

3. Fixing accessories for flat and round conductors /

3.3 Vertical and horizontal fixings

Support for bus-bar

Description Support clip to fix flat conductors.

Material Stainless steel.

CLIP-30

Ref.	Material	Bus-bar (mm)	Kg/100 U	U
CLIP-30	Stainless steel	30 x 2	0,2	100
Rivet-lx-etanche Ø 4	Aluminium		0,1	100
S-30x2/140	Tin A/Copper + Stainless steel clip	30 x 2	6	10



Support

Description Copper bus-bar connection clamp to structure formed by two hot-stamping bodies and tightening with two hexagonal studs.

Material **Body:** copper-rich alloy (Brass).
Hardware: stainless steel.

PBL

Ref.	Bus-bar dimensions	A (mm)	B (mm)	C (mm)	Fixing thread	Kg/U
PBL-30	30	20	60	7,5	M 6 x 25	0,15
PBL-40	40	20	70	7,5	M 8 x 12	0,17
PBL-50	50	24	87	8	M 10 x 15	0,35
PBL-60	60	30	95	9	M 10 x 15	0,44



Fixing element

Description Fixing for bus-bar conductors to flat surface.

Material **Body:** galvanised steel.
Hardware: plastic.

CMG-30

Ref.	Dimensions	Kg/ 100 U	U
CMG-30	30 x 2 - 30 x 4	2	100 or 500
CHPB	Ø 5 x 30	0,50	100



Dimensions indicated are nominal

3. Fixing accessories for flat and round conductors / 3.3 Vertical and horizontal fixings

Collar and tool



Description	Collar. Tool to hold washers of 4.6 or 7.9 mm wide.
Material	Stainless steel.

CSIX and P/CB				
Ref.	Length (mm)	Max. Supp Ø Máx (mm)	Resistance to traction (daN)	U
CSIx-200/4,6	201	51	45	100
CSIx-362/4,6	360	102	45	100
CSIx-521/4,6	520	152	45	100
CSIx-680/4,6	679	203	45	100
CSIx-838/4,6	838	254	45	100
CSIx-1067/4,6	1.016	305	45	100
CSIx-200/7,9	201	51	113	100
CSIx-362/7,9	360	102	113	100
CSIx-521/7,9	520	152	113	100
CSIx-680/7,9	679	203	113	100
CSIx-838/7,9	838	254	113	100
CSIx-1067/7,9	1.016	305	113	100

Supports

Description	Earthing collar for pipes.
Material	Fixing body: nickel-plated brass. Belt: tinned bronze.



COE						
Ref.	Section (mm ²)	Ø Pipe (mm)		Collar width x Length (mm)	g	U
		Min	Máx			
COE/2.5-6/8-18	12	8,0	17,5	15 x 140	30,5	10
COE/2.5-16/18-48	14	17,5	48	15 x 200	60	10
COE/2.5-16/18-114	16	17,5	114	23 x 410	72	10
COE/2.5-16/18-165	18	17,5	165	23 x 560	80	10

Dimensions indicated are nominal

3. Fixing accessories for flat and round conductors /

3.4 Fixings for roofs

Supports

Description Pyramidal support for conductors on roofs.

Material **Body:** concrete.
Coverage: plastic.

PLOTBET - PVC (30 PVC and 8 PVC)

Ref.	Dimensions	Capacity (mm)	Kg/U	U
PLOTBET - 8 PVC	140 x 140 x 70	Ø 8 - Ø 10	1	20
PLOTBET - 30 PVC	140 x 140 x 80	≤ 30 x 4 / Ø 6 - Ø 11	1	20



PLOTBET-30PVC



PLOTBET-8PVC

Concrete supports

Description Round conductor fixing. Plastic bearing.

Material **Body:** concrete.
Base and collar: plastic.

PLOTBET - 30

Ref.	Material	Dimensions	Capacity (mm)	Kg/U	U
PLOTBET - 30	Concrete	100 x 100 x 70	≤ 30 x 4 / Ø8	1	10



Tight fixing

Description Fixings for flat conductors.

Material Tarred aluminium.

RUBERALU

Ref.	Dimensions	Kg	U
Ruberalu	Rol of tape de 10 m	6	1



Supports

Description Terminal for connection of conductors to roof gutter.

Material Galvanised steel.

BG-RD8-AG

Ref.	Kg	U
BG-RD8-AG	0,19	25



Supports

Description Support to fix 8 mm conductors on roof.

Material Copper.

S-RD 8/335

Ref.	Length (mm)	Kg	U
S-Rd 8 / 335	335	0,93	50



Dimensions indicated are nominal

Lightning arrester



Description Lightning arrester with discharge devise.

PDA

Ref.	Name	Ø (mm)	H (mm)	Kg	U
PDA TS 2,25 M 20	E.S.E.L.C. 25 µs	100	330	3,3	1
PDA TS 3,40 M 20	E.S.E.L.C. 40 µs	100	330	3,4	1
PDA TS 4,50 M 20	E.S.E.L.C. 50 µs	185	385	5,5	1
PDA TS 6,60 M 20	E.S.E.L.C. 60 µs	185	385	5,6	1

Posts



Description Extendable masts.

Material Galvanised steel with variant in Stainless steel.

MR

Ref.	Section Ø (mm)	H (mm)	Kg	U
MR-200-1-AG-35 (A)	35	2	3	1
MR-200-2-AG-42 (B)	42	2	5	1
MR-200-3-AG-50 (C)	50	2	5	1
MR-3.75-AG (A+B)	A + B Set	3,75	8	1
MR-5.5-AG (A+B+C)	A + B + C Set	5,50	13	1

TSP

Description Fixing support.

Material Galvanised steel.



TSP

Ref.	Width x Height (mm)	Kg	U
TSP-AG/35	360 x 320	4	1
TSP-AG/50	515 x 470	7	1

Dimensions indicated are nominal

4. Protection against-lightning /

4.2 Lightning arrester

PSP

Description Support plate with bolt M 10 for fixing catchment point.

Material Stainless steel.

PSP IX EQ and PSP IX

Ref.	Kg/U	U
PSP Ix EQ	0,15	1
PSP Ix	0,90	1



PSP Ix EQ

Collar

Material Stainless steel.

CIX-30

Ref.	Description	Material	Kg	U
CIX-30	Tightening collar for conductor of 30 mm	Stainless steel	0,2	1



PC

Description Catchment Point.

Material Stainless steel.

PC

Ref.	Material	Ø (mm)	Length	Kg	U
PC-50/18lx	Inox	Ø 18	500	0,95	1
PC-100/18lx	Inox	Ø 18	1.000	2,00	1



Dimensions indicated are nominal

Supports

Description Support for fixing different types of lightning rod.

Material Galvanised steel.

	Ref.	Ø (mm)	Length (mm)	Kg	U
	PDC 20 AG-H	Ø 22 to 55	200	1,5	1
	PDC 20 AG-V	Ø 22 to 55	200	1,5	1
	PDC 30 AG-H	Ø 22 to 55	300	2,0	1
	PDC 30 AG-V	Ø 22 to 55	300	2,0	1
	PS-AG	Ø 22 to 55	300	1,5	1
	PDD-24 AG	Ø 22 to 55	240	1,5	1
	PB-13AG	Ø 22 to 55	130	1,0	1
	CXD-AG	Ø 22 to 55	--	0,5	1
	CX-AG	Ø 22 to 55	--	0,5	1
	CK-AG	Ø 22 to 55	--	0,5	1

Dimensions indicated are nominal

4. Protection against-lightning /

4.3 Supports

Signage plate

Description	Signage plate in Spanish, English or French: Earthing.
Material	Aluminium.
Dimensions	10 x 10 x 10 cm.
Weight	110 g.



Signage board



4. Protection against-lightning /

4.4 Accessoires for down pipes

Clamp for flat / Round conductor

Description	Brass connection terminal made by hot-stamping for flat or round conductor. For bolt M6 DIN 912.
Material	Tinned copper-rich alloy (Brass).

BC-30/8

Ref.	Lenght (L: mm)	Capacity (mm)	Kg/U	U
BC 30-8	70	30 x 2 - 30 x 3,5 Ø6 - Ø8	0,40	1



Dimensions indicated are nominal

Protection for flat conductor

Description	Protection for flat conductor of up to 30x4 mm supplied with 3 fixings.
Material	Protection: galvanised steel / stainless steel. Fixings: stainless steel.



FP-30/2 and FP-30/2IX

Ref.	Length (mm)	Kg/U	U
FP-30/2	2.000	1,2	1
FP-30/2lx	2.000	1,2	1

Digital meter CTR-8



Description	Digital Meter which allows counting the lightning discharges at an outdoor lightning protection installation. The digital screen enables directly reading the amount of impacts recorded. The recording of the lightning discharges and their memorisation does not need any exterior power supply, so it does not depend on the duration of the battery. Only the digital screen, directed by a front button requires a power supplied by a long-lasting lithium battery.
Installation	Installed directly on the down conductor. No interruption of the conductor is required which allows an excellent electrical continuity from the point to the earthing. The meter records the lightning power when it passes through the down conductor.
Characteristics	Meter conforming to standard UTE C17106 Minimum detection power(I_d) $> = 1$ kA Maximum power detection ($I_{max.}$) $< = 100$ kA Lack of detection power (I_{nd}) $= I_d / 3 = 333$ A Protection indexes IP 54

Dimensions indicated are nominal

4. Protection against-lightning /

4.4 Accessoires for down pipes

Meter CTR-8

Description	Meter with mechanical indicator which allows counting the lightning discharges at an outdoor lightning protection installation.
Characteristics	Meter conforming Standard UTE C-17-106 Minimum detection power (Id) > = 0,7 kA Maximum detection power (Imax.) < = 100 kA Protection indexes IP 65



Meter CTR-8SA

Description	Digital Meter which allows counting the lightning discharges of an intensity between 1 kA and 100 kA. This meter is connected in series with a round conductor of 8 to 10 mm diameter or bus-bar of 30x2.
Characteristics	Conforming Directive CEM Sensitivity: 200A (8/20 μs) Minimum detection power (Id) > = 0,7 kA Maximum detection power (Imax.) < = 100 kA (8/20 μs) Protection index: IP 65



Switch box

Description	Box made of insulating material which includes a switch used to check the earthing resistance in the transformer stations.
Characteristics	Housing: resistant polycarbonate at 960° C. Connections: electrolytic tin copper of 20x3 mm. Connection terminals: C Feedthrough cones: PVC



Dimensions indicated are nominal



Disconnecting link

Description Disconnecting link for round conductor.

Characteristics **Body:** plastic.
Hardware: brass.



BCT

Ref.	Dimensions (mm)	Section Cable (mm ²)	Kg/U	U
BCT-35	125 x 30 x 26	10-35	0,135	1
BCT-70	150 x 34 x 65	10-70	0,270	1
BCTI-50	150 x 45 x 70	10-50	0,350	1

Test link

Description Test link for the disconnection of the underground power from the aerial and perform the correct measurement of the Earthing Resistance. Formed by three copper busbars fixed with two hexagonal screws. The fixing to the support is not included in the supply.

Material **Test link:** electrogalvanised copper bus-bar.
Hardware: stainless steel.



PT

Type	Dimensions Bus-bar (mm)	Section conductor cable Max (mm ²)	Kg/U
PT-3	25 x 3	75	0,29
PT-4	25 x 4	100	0,38
PT-5	25 x 5	125	0,45
PT-6	25 x 6	150	0,55

Dimensions indicated are nominal

5. Equipotential links /

5.1 Solid copper slotted and threaded bars

Slotted and threaded bars

Description Slotted and threaded bars.

Material Copper.

C					
Ref.	Size (mm)	Diameter (mm)	A (mm)	Kg/m	U
Plain hole, Length 1.750 mm Double					
C-1750/25 x 5/10	25 x 5 x 1.750	10,5	25	1,66	1
Double holes, Length 1.750					
C-1750/50 x 5/10	50 x 5 x 1.750	10,5	25	3,32	1
C-1750/80 x 5/10	80 x 5 x 1.750	10,5	25	5,30	1
C-1750/100 x 5/10	100 x 5 x 1.750	10,5	25	6,64	1
Threaded hole, Length 1.000					
C-1000/18 x 4/M 8	18 x 4 x 1.000	8	25	0,64	1
C-1000/30 x 10/M 8	30 x 10 x 1.000	8	25	2,67	1
Threaded hole, Length 990					
C-990/12 x 4/M 5	12 x 4 x 990	5	25	0,36	1
C-990/20 x 5/M 6	20 x 5 x 990	6	25	0,76	1
C-990/32 x 5/M 6	32 x 5 x 990	6	25	1,22	1
Plain hole					
C-280-6-8	50 x 5 x 280	8,5	35	0,63	1
C-420-10-8	50 x 5 x 420	8,5	35	0,94	1
C-595-15-8	50 x 5 x 595	8,5	35	1,32	1
C-770-20-8	50 x 5 x 770	8,5	35	1,71	1
C-945/25/8	50 x 5 x 945	8,5	35	2,10	1
Double hole, Length 300					
C-300/100 x 10/10	100 x 10 x 300	10,5	30	2,67	1

* Other dimensions upon request.

Copper bars

Description Copper bars.

Material Copper.

C			
Ref.	Size (mm)	Kg/m	ml
C 25 x 3	25 x 3	0,668	3
C 25 x 5	25 x 5	1,112	3
C 40 x 5	40 x 5	1,780	3
C 50 x 5	50 x 5	2,225	3
C 80 x 5	80 x 5	3,560	3
C 100 x 5	100 x 5	4,450	3
C 100 x 10	100 x 10	8,900	3

* Other dimensions upon request.

Dimensions indicated are nominal



Earthing bars

Description Equipotentiality bar. Slotted for 6-10-15-20-25 connections on copper bus-bar of 50x5. Mounted with insulators on perforated profile for an easy fixing.

Material **Bar:** copper.
Insulators: fibreglass - polyester.

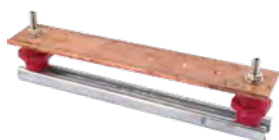

BE				
Ref	Length (mm)	Number of holes (mm)	Kg/U	U
BE-280/6/8	280	06	1,25	1
BE-420/10/8	420	10	1,75	1
BE-595/15/8	595	15	2,25	1
BE-770/20/8	770	20	2,80	1
BE-945/25/8	945	25	3,35	1

Earthing bars

Description Perforated bus-bar with or without insulators.

Material Copper.



C-300/100X10/10 and BC-300/100X10/10				
Ref	Length (mm)	Number of holes (mm)	Kg/U	U
BE-300/100 x 10/10	300	2 x 10	3	1
C-300/100 x 10/10	300	2 x 10		

Earthing bars with disconnecting link

Description Equipotentiality bar with incorporated disconnecting link. Perforated for 6-10-15-20-25 connections on copper bus-bar of 50x5. Mounting with insulators on perforated profile for an easy fixing.

Material **Bar:** copper.
Insulators: fibreglass - polyester.

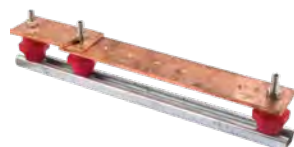

BEC				
Ref	Length (mm)	Number of holes (mm)	Kg/U	U
BEC-280/6/8	350	6	1,65	1
BEC-420/10/8	490	10	2,15	1
BEC-595/15/8	665	15	2,65	1
BEC-770/20/8	770	20	3,20	1
BEC-945/25/8	1.015	25	3,75	1

Dimensions indicated are nominal

5. Equipotential links /
5.2 Equipotentiality bars

Disconnecting link

Description Copper bus-bar disconnecting link of 50x5, mounted on clamping profile.

Material **Bar:** copper.
Insulators: fibreglass - polyester.



BC-200/3/8

Ref	Length (mm)	Kg/U	U
BC-200/3/8	110	0,70	1

Fibreglass-Polyester insulators

Description Insulators with high mechanical resistance and high electrical properties. They can be used in unfavourable environmental conditions.

Material fibreglass - polyester.

ISO-FF

Ref	Height (mm)	M	Kg/U	U
ISO-35FFM6	35	6 x 9	0,083	10
ISO-35FFM8	35	8 x 10	0,081	10
ISO-35FFM10	35	10 x 10	0,077	10
ISO-50FFM6	50	6 x 15	0,178	10
ISO-50FFM8	50	8 x 15	0,172	10
ISO-50FFM10	50	10 x 15	0,168	10
ISO-80FFM2	80	12 x 20	1,485	4



Dimensions indicated are nominal



Earthing bars

Description Equipotentiality earthing bar to mount on concrete formed by a copper bus-bar with KBH type clamps to connect the cables.

Material **Equipotentiality bus-bar:** electrogalvanised copper.
Clamps. Body: copper-rich alloy (Brass).
Hardware: stainless steel.
Fixings: electrogalvanised steel.

For earthing bars with more clamps or combined upon request.

EC								
Ref	N° of clamps	Section Conductor Cable (mm ²)		A (mm)	B (mm)	C (mm)	D	Kg/U
EC 70-2	2	25	70	60	195	6	170	1,15
EC 70-3	3				265		240	1,55
EC 70-4	4				335		310	2,00
EC 70-5	5				405		380	2,45
EC 70-6	6				475		450	2,91
EC 100-2	2				70		95	60
EC 100-3	3	265	240	1,67				
EC 100-4	4	335	310	2,13				
EC 100-5	5	405	380	2,65				
EC 100-6	6	475	450	3,16				
EC 200-2	2	95	185	60		195		
EC 200-3	3				265	240	2,51	
EC 200-4	4				335	310	3,25	
EC 200-5	5				405	380	4,05	
EC 200-6	6				475	450	4,86	

Dimensions indicated are nominal

5. Equipotential links /

5.3 Flanges

Earth braids (1 of 2)

Description Manufactured with flat copper braid and with flat tabs on both ends.

Material Tinned copper.

TE							
Ref.	S (mm ²)	I Amp	L (mm)	Dimensions			U
				X (mm)	Y (mm)	Ø/ (mm)	
TE-10/100/6.5	10	75	100	14	3,5	6,5	50/100
TE-10/150/6.5	10	75	150	14	3,5	6,5	50/100
TE-10/200/6.5	10	75	200	14	3,5	6,5	50/100
TE-10/250/6.5	10	75	250	14	3,5	6,5	50/100
TE-10/300/6.5	10	75	300	14	3,5	6,5	50/100
TE-16/100/8.5	16	120	100	17	4	8,5	50/100
TE-16/150/8.5	16	120	150	17	4	8,5	50/100
TE-16/200/8.5	16	120	200	17	4	8,5	50/100
TE-16/250/8.5	16	120	250	17	4	8,5	50/100
TE-16/300/8.5	16	120	300	17	4	8,5	50/100
TE-16/350/8.5	16	120	350	17	4	8,5	50/100
TE-16/400/8.5	16	120	400	17	4	8,5	50/100
TE-25/100/8.5	25	150	100	23	4	8,5	25/50
TE-25/150/8.5	25	150	150	23	4	8,5	25/50
TE-25/200/8.5	25	150	200	23	4	8,5	25/50
TE-25/250/8.5	25	150	250	23	4	8,5	25/50
TE-25/300/8.5	25	150	300	23	4	8,5	25/50
TE-25/350/8.5	25	150	350	23	4	8,5	25/50
TE-25/400/8.5	25	150	400	23	4	8,5	25/50
TE-35/100/10.5	35	190	100	27	4,2	10,5	25/50
TE-35/150/10.5	35	190	150	27	4,2	10,5	25/50
TE-35/200/10.5	35	190	200	27	4,2	10,5	25/50
TE-35/250/10.5	35	190	250	27	4,2	10,5	25/50
TE-35/300/10.5	35	190	300	27	4,2	10,5	25/50
TE-35/350/10.5	35	190	350	27	4,2	10,5	25/50
TE-35/400/10.5	35	190	400	27	4,2	10,5	25/50
TE-50/100/10.5	50	250	100	33	5	10,5	25
TE-50/150/10.5	50	250	150	33	5	10,5	25
TE-50/200/10.5	50	250	200	33	5	10,5	25
TE-50/250/10.5	50	250	250	33	5	10,5	25
TE-50/300/10.5	50	250	300	33	5	10,5	25
TE-50/350/10.5	50	250	350	33	5	10,5	25
TE-50/400/10.5	50	250	400	33	5	10,5	25
TE-50/500/10.5	50	250	500	33	5	10,5	25



Section: 25 mm²
 Ø Hole: 8,5 mm
 Length: 300 mm

Dimensions indicated are nominal

Earth braids (2 of 2)

TE							
Ref.	S (mm ²)	I (Amp)	L (mm)	Dimensions			U
				X (mm)	Y (mm)	Ø/ (mm)	
TE-70/150/12,5	70	290	150	32	5,5	12,5	25
TE-70/200/12,5	70	290	200	32	5,5	12,5	25
TE-70/250/12,5	70	290	250	32	5,5	12,5	25
TE-70/300/12,5	70	290	300	32	5,5	12,5	25
TE-70/400/12,5	70	290	400	32	5,5	12,5	25
TE-70/500/12,5	70	290	500	32	5,5	12,5	25

Earth braids

Description Manufactured with flexible braided cable with compression terminals mounted on both ends.

Material Cable and terminals: tinned copper.

TEC					
Ref.	S (mm ²)	I (Amp)	L (mm)	Ø (mm)	U
TEC-6/100/6,5	6	40	100	6,5	50/100
TEC-6/150/6,5	6	40	150	6,5	50/100
TEC-6/200/6,5	6	40	200	6,5	50/100
TEC-6/250/6,5	6	40	250	6,5	50/100
TEC-6/300/6,5	6	40	300	6,5	50/100
TEC-6/400/6,5	6	40	400	6,5	50/100
TEC-10/150/6,5	10	75	150	6,5	50/100
TEC-10/200/6,5	10	75	200	6,5	50/100
TEC-10/250/6,5	10	75	250	6,5	50/100
TEC-10/300/6,5	10	75	300	6,5	50/100
TEC-10/400/6,5	10	75	400	6,5	50/100
TEC-10/500/6,5	10	75	500	6,5	50/100
TEC-16/150/8,5	16	120	150	8,5	50/100
TEC-16/200/8,5	16	120	200	8,5	50/100
TEC-16/250/8,5	16	120	250	8,5	50/100
TEC-16/300/8,5	16	120	300	8,5	50/100
TEC-16/400/8,5	16	120	400	8,5	50/100
TEC-16/500/8,5	16	120	500	8,5	50/100
TEC-25/150/8,5	25	150	150	8,5	50/100
TEC-25/200/8,5	25	150	200	8,5	50/100
TEC-25/250/8,5	25	150	250	8,5	50/100
TEC-25/300/8,5	25	150	300	8,5	50/100
TEC-25/400/8,5	25	150	400	8,5	50/100
TEC-25/500/8,5	25	150	500	8,5	50/100

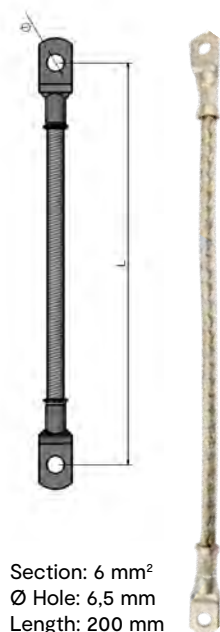

Section: 6 mm²
 Ø Hole: 6,5 mm
 Length: 200 mm

Dimensions indicated are nominal

6. Conductors /
 6.1 Conductors

Insulated copper conductor
Description Insulated copper conductor green, yellow.

Material Copper.

H07-V

Ref.	Section (mm ²)	Composition (n°. wires x Ø mm)	Kg/m	ml
H07-VK-1x6	6	84 x 0,31	0,060	100 & coil
H07-VR-1x6	6	7 x 1,04	0,070	100 & coil
H07-VK-1x10	10	80 x 0,41	0,100	100 & coil
H07-VR-1x10	10	7 x 1,35	0,110	100 & coil
H07-VK-1x16	16	126 x 0,41	0,160	100 & coil
H07-VR-1x16	16	7 x 1,70	0,160	100 & coil
H07-VK-1x25	25	196 x 0,41	0,250	100 & coil
H07-VR-1x25	25	7 x 2,14	0,260	100 & coil
H07-VK-1x35	35	276 x 0,41	0,340	100 & coil
H07-VR-1x35	35	7 x 2,52	0,360	100 & coil
H07-VK-1x50	50	396 x 0,41	0,460	50 & coil
H07-VR-1x50	50	19 x 1,78	0,480	50 & coil
H07-VK-1x70	70	360 x 0,51	0,680	coil
H07-VR-1x70	70	19 x 2,14	0,740	coil
H07-VK-1x95	95	475 x 0,51	0,954	coil
H07-VR-1x95	95	19 x 2,52	0,960	coil
H07-VK-1x120	120	608 x 0,51	1,200	coil
H07-VR-1x120	120	37 x 2,03	1,152	coil



Dimensions indicated are nominal

Round solid conductors

Description Round solid conductor.

Material See table.



RD				
Ref.	Diameter (Ø mm)	Material	Kg/m	ml
RD-6	6	Pure copper	0,250	100-120
RD-8	8	Pure copper	0,448	50-60
RD-8/E	8	Tin copper	0,448	50-60
RD-8/3	8	Pure copper	0,448	3
RD-8AG	8	Galvanised steel	0,393	100-130
RD-8lx	8	Stainless steel	0,900	90-110
RD-10AG	10	Galvanised steel	0,617	50-80
RD-10 lx	10	Stainless steel	0,625	50-80
RD-8Al	8	Aluminium	0,135	150
RD-10Al	10	Aluminium	0,210	100

Flat conductors

Description Flat conductor.

Material Tinned copper, stainless steel. 304 and 316, aluminum and galvanized steel.



CE-AI-AG				
Ref.	Size (mm)	Material	Kg/m	ml
CE-27x2	27 x 2,0	Tinned copper	0,480	50
CE-30x2	30 x 2,0	Tinned copper	0,534	60
AI-30x3,5 V2A	30 x 3,5	Stainless steel 304	0,830	60
AI-30x3,5 V4A	30 x 3,5	Stainless steel 316	0,830	60
ALU-30x3	30 x 3,0	Aluminium	0,243	110
AG70-30x3,5	30 x 3,5	Galvanised steel (70 µm)	0,840	50

* Consult for other dimensions.

Dimensions indicated are nominal

6. Conductors /

6.4 Copper and steel conductors

Copper conductors

Description Braided conductor.

Material Copper.

CRR				
Ref.	Section (mm ²)	Composition (n° wires x Ø mm)	g/m	ml
CRR-16	16	7 x 1,71	0,144	50/100/coil
CRR-25	25	7 x 2,13	0,225	50/100/coil
CRR-29	29	19 x 1,40	0,267	50/100/coil
CRR-35	35	7 x 2,50	0,305	50/100/coil
CRR-50	50	19 x 1,77	0,420	25/50/coil
CRR-70	70	19 x 2,14	0,600	25/50/coil
CRR-95	95	19 x 2,52	0,830	25/50/coil
CRR-120	120	19 x 2,94	1,040	coil
CRR-120/37	120	37 x 2,05	1,065	coil
CRR-150	150	19 x 3,24	1,260	coil
CRR-150/37	150	37 x 2,21	1,260	coil
CRR-185	185	37 x 2,50	1,620	coil
CRR-240	240	61 x 2,28	2,200	coil
CRR-300	300	61 x 2,50	2,650	coil



Steel conductor

Description Braided conductor.

Material Hot-Galvanised steel.

CAG				
Ref.	Section (mm ²)	Composition (n° wires)	Kg/m	ml
CAG-50/50	50	19	0,46	coil
CAG-70/50	70	19	0,60	coil
CAG-95/50	95	19	0,80	100 m roll



Dimensions indicated are nominal

Flat copper braid

Description Flat braid.

Material Tinned copper.



AE

Ref.	Section (mm ²)	Dimensions	Kg/100m	U (ml)
AE-2,5	2,5	4,5 x 13	2,5	100
AE-5	5,0	8 x 1,4	5,0	25-50
AE-10	10,0	12 x 1,8	10,0	25-50
AE-16	16,0	15 x 2,0	16,0	25-50
AE-30	30,0	25 x 2,5	30,0	25-50
AE-35	35,0	27 x 2,8	35,0	25-50
AE-50	50,0	30 x 3,5	50,0	25-50
AE-70	70,0	30 x 5,0	70,0	25

Round copper braid

Description Round copper braid.

Material Tinned copper.



RDE

Ref.	Section (mm ²)	Nominal diameter (mm)	Kg/100m	U (ml)
RDE-6	6	4	6	100
RDE-10	10	5	10	100
RDE-16	16	6	16	50
RDE-25	25	8	25	50
RDE-35	35	9	35	50
RDE-50	50	11	50	25
RDE-70	70	13	70	25

Dimensions indicated are nominal

6. Conductors /
6.5 Round and flat braids

Flat copper braid

Description	Flat copper braid with PVC coating.
Material	Body: tin copper. Coating: PVC.

AE-PVC				
Ref.	Section (mm ²)	Dimensions (mm)	Kg/100m	U (ml)
AE-10PVC	10	12 x 3,5	15	50
AE-16PVC	16	17 x 3,5	23	50
AE-25PVC	25	27 x 4,0	35	50
AE-35PVC	35	29 x 4,0	46	50
AE-50PVC	50	28 x 7,0	65	50
AE-70PVC	70	30 x 5,0	95	25



Round copper braid

Description	Round braid.
Material	Body: tin copper. Coating: PVC.

RDE-PVC				
Ref.	Section (mm ²)	Dimensions (mm)	Kg/100m	U
RDE-10PVC	10	7	13	50
RDE-16PVC	16	8	19	50
RDE-25PVC	25	10	35	50
RDE-35PVC	35	12	53	50
RDE-50PVC	50	13	71	50



Dimensions indicated are nominal

KLK-weld procedure

The **KLK-weld procedure** utilizes the high temperature reached during the reduction reaction between copper oxide and aluminum. The reaction takes place inside a graphite crucible-mold, into which the parts to be welded have been inserted; the melted metal from the aluminothermic reaction flows over the parts, melting them and forming a compact, homogeneous mass.

The reaction is so quick that the parts to be welded in the area surrounding the welding point, acquire a lower temperature than that obtained using other procedures. This is an important factor for protecting cable insulation or the physical characteristics of the parts to be welded.

KLK-weld can be used to weld copper to copper or copper to steel. For other materials, please contact us.

The **KLK-weld connection** is a perfect molecular weld and not just a mechanical contact. The alloy used has practically the same melting point as that of copper and usually has a cross-section approximately double than that of the conductors to be welded, so:

- * Connections are not affected by high current surges. Tests have shown that the electrical conductors will melt before the connection when subject to high short-circuit current.
- * Connection conductivity is at least equal or greater than that of the conductors welded.
- * There is no possibility of galvanic corrosion at the welding point, as the conductors become an integral part of the connection.

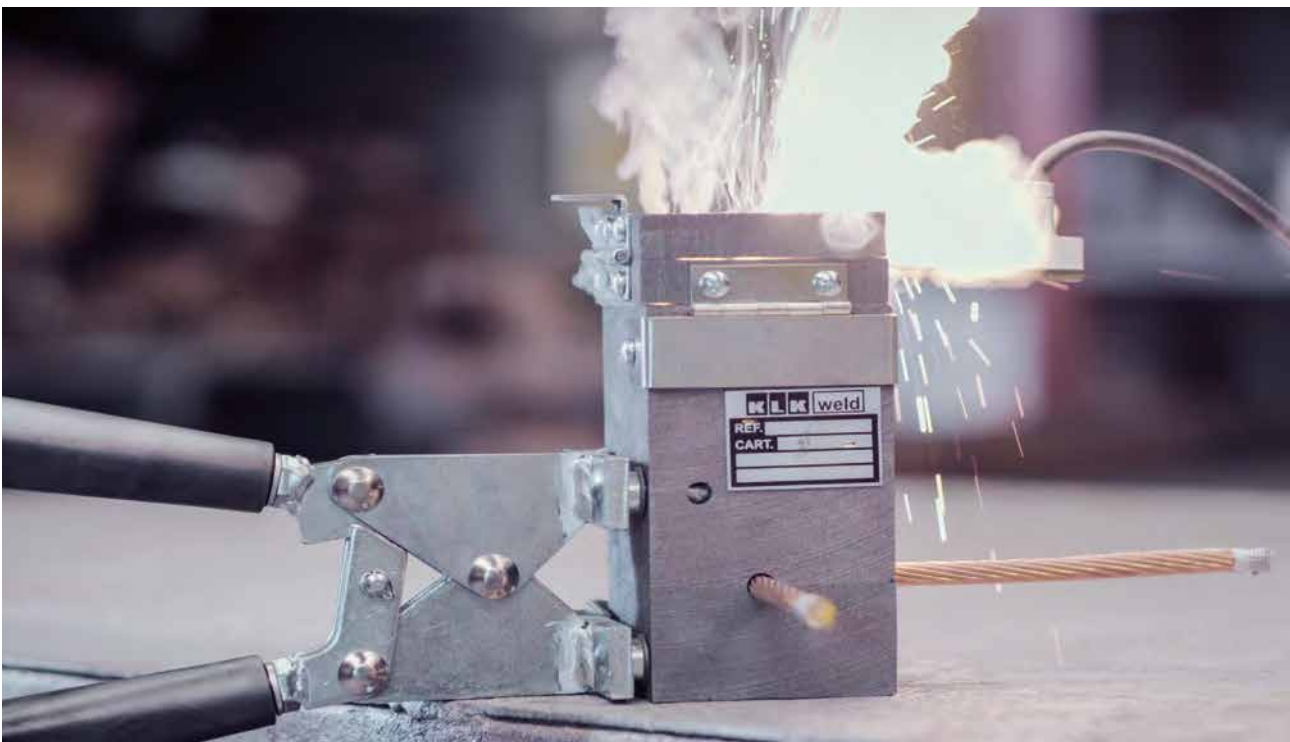

7. Copper aluminothermic welding /

KLK-weld mould

Molds for welding galvanized steel cable add to the end of the mold reference GS.
(Example **CC-L35 GS**)

Welding molds for stainless steel wire add to the end of the SS mold reference.
(Example **CC-L35 SS**)

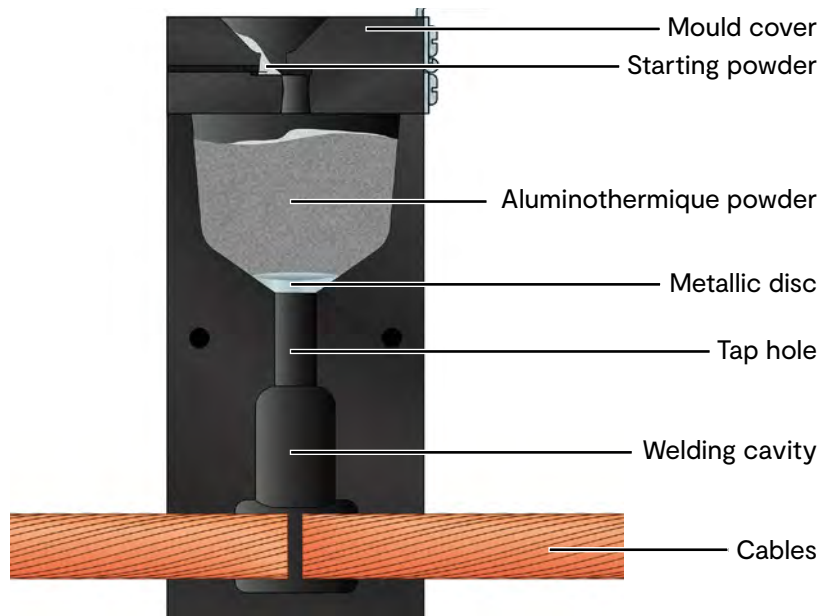

KLK-weld cartridges and discs

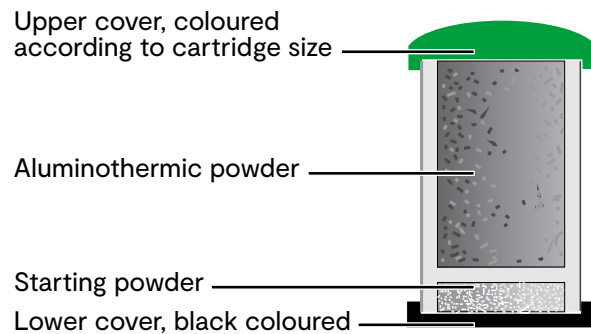

Cartridges	C-15	C-25	C-32	C-45	C-65	C-90	C-115	C-150	C-200	C-250
Colour	Light grey	Grey	Purple	White	Yellow	Orange	Red	Brown	Blue	Green
Units. / Box	20	20	20	20	10	10	10	10	10	10

KLK-weld equipment

The **KLK-WELD equipment** is light and portable, and does not require any external power source, making it suitable for field use. Non-specialist personnel can achieve optimal electrical connections and high mechanical quality in a very short time

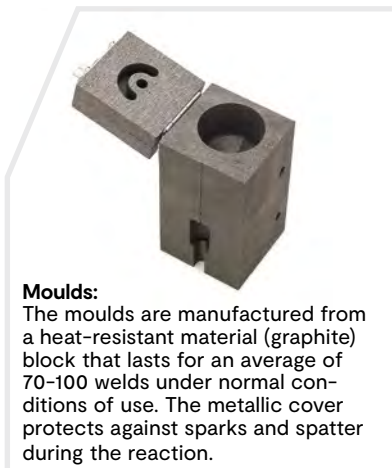

7. Copper aluminothermic welding /

Tables of cables, bus-bars and earth rods

The moulds are cut to fit the type and size of copper conductors, concrete steel re-bars and earth rods shown on these tables. For any other type and/or size, it is necessary to confirm the actual overall diameter.

Copper conductors (UNE 21012)

Section (mm ²)	Composition	Ø Exterior (mm)
10	7 x 1,35	4,05
16	7 x 1,70	5,10
25	7 x 2,14	6,42
35	7 x 2,52	7,56
50	19 x 1,83	9,15
70	19 x 2,17	10,85
95	19 x 2,52	12,60
120	19 x 2,85	14,25
150	37 x 2,25	15,75
185	37 x 2,52	17,64
235	37 x 2,85	19,95
300	61 x 2,62	22,68
400	61 x 2,85	25,65

Concrete steel re-bars

Ø Nominal	Ø Exterior (mm)
6	7,2
8	9,6
10	12,0
12	14,4
14	16,8
16	19,2
20	24,0
25	30,0

Copper-steel earth rods

Earth rod type	Ø Exterior (mm)
J - ...58	14,3
J - ...34	17,3
...NU 146	14,6
...NU 183	18,3
...ST 143	14,3

Preparing material

Preparing the cables

For a perfect weld the cable must be perfectly clean, dry and shaped.

- * Cables treated with oil or grease should be cleaned with a degreaser (preferably a solvent that dries quickly and leaves no residue). In extreme cases, heat the cable with a blowtorch, which will completely remove grease or oil.
- * Rusty cables should be polished with a wire brush.
- * A cable that is wet or coated in mud will cause porous welding and emissions of molten metal out of the mold. It should be dried with a blowtorch to remove mud residues.
- * Wrongly-cut or shaped cables will prevent the correct closing of the mold, causing leaks of molten metal.

Preparing the grounding rods

The end of the rod to be welded must be perfectly clean, dry and flat, as for the cables.

Preparing the steel surfaces

The surface must be free of rust and perfectly dry and flat.

- * The layer of rust, paint, grease, or dirt should be cleaned using a grinding wheel preferably.
- * Dry any moisture with a blowtorch.
- * Galvanized surfaces should be cleaned without removing the zinc layer.

Preparing the graphite mold

Moisture in the mold will produce a porous weld, so ensure it is completely dry before welding.

Before the first weld, heat the mold until it is too hot to touch, with a blowtorch, or by burning a cartridge. If you use a cartridge take care not to damage the clamps.

For subsequent welds, the heat generated will keep the mold at the correct temperature. If the interval between welds causes the mold to cool, start the procedure over again.

Most frequent connections

Cable / Cable

CC-L



CC-TH



CC-TV



CC-DPH

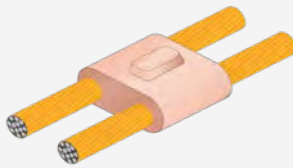

CC-X

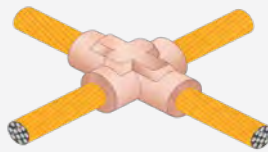

CC-XS

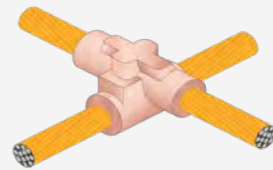

Cable / Earth rod

CP-AR



CP-TS



CP-T



CP-V



CP-VS



Earth rod / Earth rod

PP-V



Cable / Re-bar

CR-TP

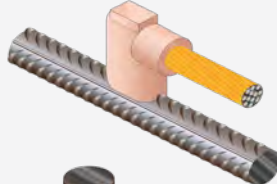

CR-XS



CR-PH

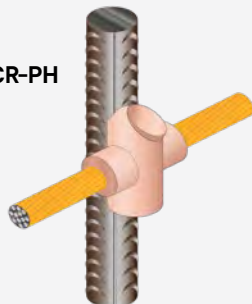

CR-TL

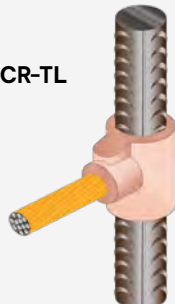

CR-TH



CR-PV

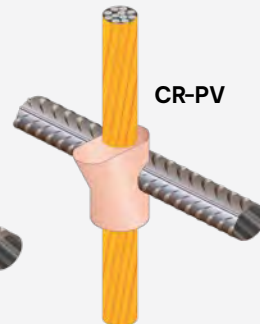

60
Copper aluminothermic welding

Most frequent connections

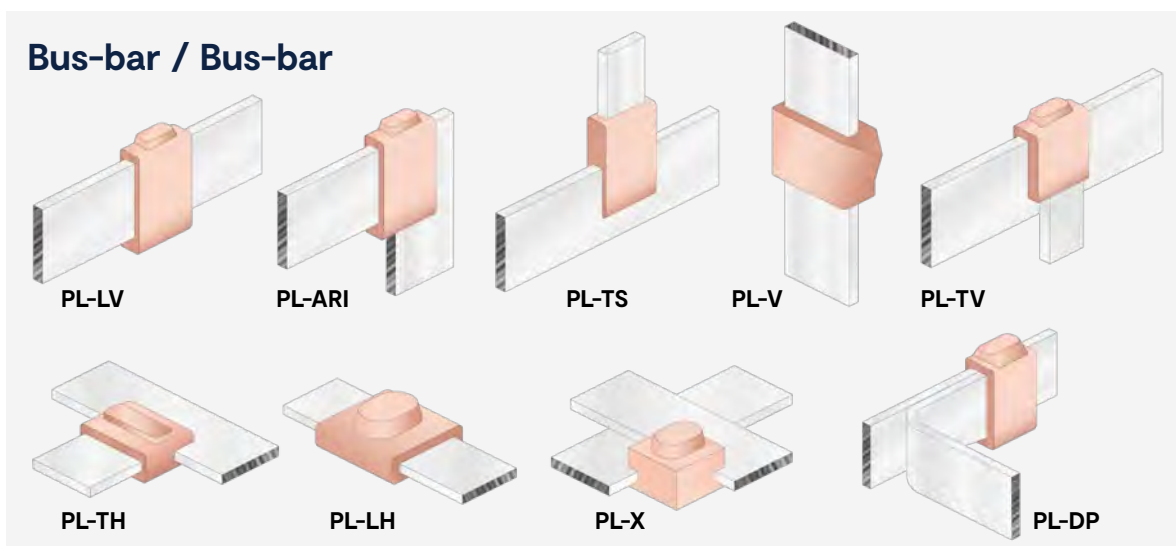
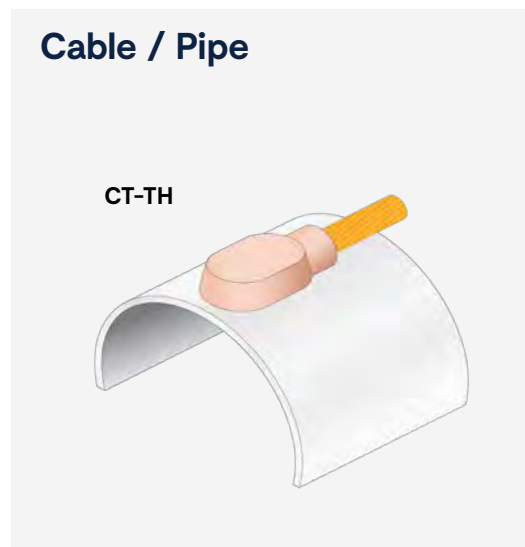
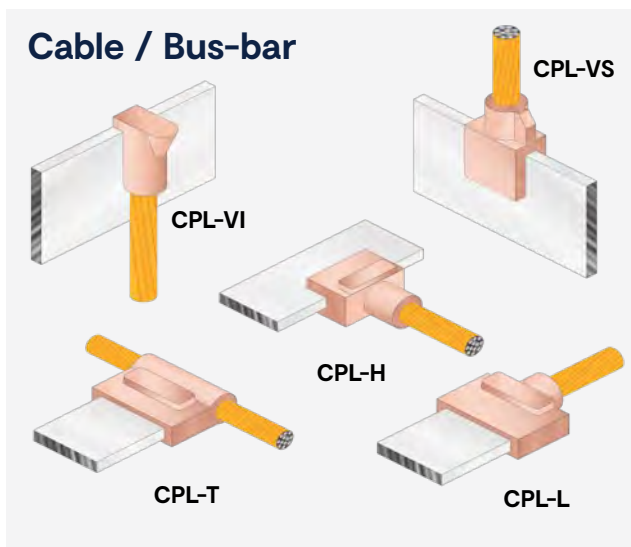
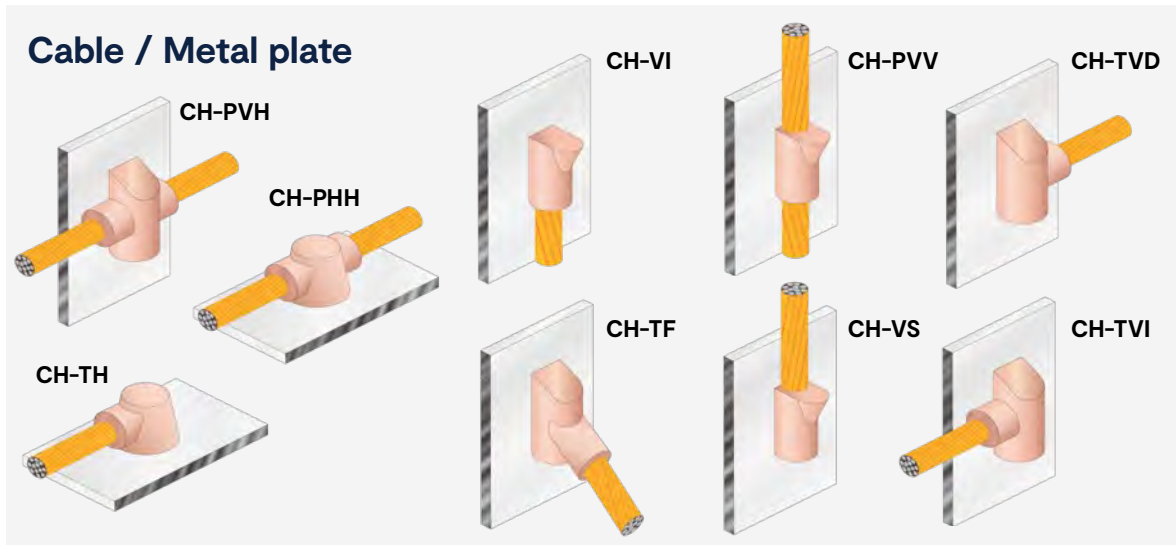

7. Copper aluminothermic welding /

7.1 Cable / Cable

Connection CC-L

Dimension cable (mm ²)					
Main	Tap cable	Mould (PART. No.)	Cartridge	Clamp	Scraper
25	25	CC-L 25	C-32*	TSC-80	R-45
35	25	CC-L 35/25	C-45*	TSC-80	R-45
	35	CC-L 35	C-45*	TSC-80	R-45
50	25	CCL 50/25	C-45*	TSC-80	R-45
	35	CC-L 50/35	C-45*	TSC-80	R-45
70	50	CC-L 50	C-45*	TSC-80	R-45
	25	CC-L 70/25	C-45*	TSC-80	R-45
70	35	CC-L 70/35	C-65	TSC-80	R-45
	50	CC-L 70/50	C-65	TSC-80	R-45
	70	CC-L 70	C-65	TSC-80	R-45
95	25	CC-L 95/25	C-65	TSC-80	R-45
	35	CC-L 95/35	C-65	TSC-80	R-45
	50	CC-L 95/50	C-90	TSC-80	R-90
	70	CC-L 95/70	C-90	TSC-80	R-90
95	95	CC-L 95	C-90	TSC-80	R-90
	25	CC-L 120/25	C-65	TSC-80	R-45
	35	CC-L 120/35	C-65	TSC-80	R-45
	50	CC-L 120/50	C-90	TSC-80	R-90
120	70	CC-L 120/70	C-90	TSC-80	R-90
	95	CC-L 120/95	C-115	TSC-80	R-90
	120	CC-L 120	C-115	TSC-80	R-90
	25	CC-L 150/25	C-90	TSC-80	R-90
150	35	CC-L 150/35	C-90	TSC-80	R-90
	50	CC-L 150/50	C-90	TSC-80	R-90
	70	CC-L 150/70	C-90	TSC-80	R-90
	95	CC-L 150/95	C-115	TSC-80	R-90
	120	CC-L 150/120	C-115	TSC-80	R-90
150	150	CC-L 150	C-115	TSC-80	R-90
	25	CC-L 185/25	C-90	TSC-80	R-90
	35	CC-L 185/35	C-90	TSC-80	R-90
	50	CC-L 185/50	C-90	TSC-80	R-90
	70	CC-L 185/70	C-90	TSC-80	R-90
	95	CC-L 185/95	C-115	TSC-80	R-90
	120	CC-L 185/120	C-150	TSC-80	R-150
185	150	CC-L 185/150	C-150	TSC-80	R-150
	185	CC-L 185	C-150	TSC-80	R-150
	25	CC-L 240/25	C-90	TSC-80	R-90
	35	CC-L 240/35	C-115	TSC-80	R-90
	50	CC-L 240/50	C-115	TSC-80	R-90
	70	CC-L 240/70	C-115	TSC-80	R-90
	95	CC-L 240/95	C-150	TSC-80	R-150
240	120	CC-L 240/120	C-150	TSC-80	R-150
	150	CC-L 240/150	C-200	TSC-80	R-150
	185	CC-L 240/185	C-200	TSC-80	R-150
	240	CC-L 240	C-200	TSC-80	R-150

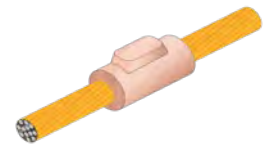

Operating instructions.
For 240 mm² cables or more, separate the points in the centre by (S) 5-6 mm approximately.

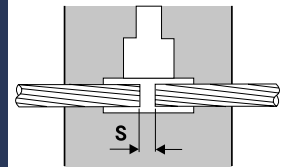

A

* Possibility of using mini moulds for cartridges C-45 or smaller, with clamp TSC-50 and scraper R-M.
• See mould price key on tariff.

7. Copper aluminothermic welding /

7.1 Cable / Cable

Operating instructions.

For 240 mm² and larger separate cables (S) 5-6 mm under the centre of the tap hole.

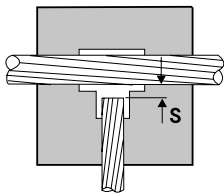
Connection CC-TH (1 of 2)

Dimension cable (mm ²)						Price key for moulds
Main	Tap cable	Mould (PART. No.)	Cartridge	Clamp	Scraper	
25	25	CC-TH 25/25	C-45*	TSC-80	R-45	A
	35	CC-TH 25/35	C-45*	TSC-80	R-45	
	50	CC-TH 25/50	C-45*	TSC-80	R-45	
35	25	CC-TH 35/25	C-45*	TSC-80	R-45	
	35	CC-TH 35/35	C-45*	TSC-80	R-45	
	50	CC-TH 35/50	C-65	TSC-80	R-45	
	70	CC-TH 35/70	C-65	TSC-80	R-45	
50	25	CC-TH 50/25	C-45	TSC-80	R-45	
	35	CC-TH 50/35	C-65	TSC-80	R-45	
	50	CC-TH 50/50	C-90	TSC-80	R-90	
	70	CC-TH 50/70	C-90	TSC-80	R-90	
70	95	CC-TH 50/95	C-90	TSC-80	R-90	
	25	CC-TH 70/25	C-65	TSC-80	R-45	
	35	CC-TH 70/35	C-65	TSC-80	R-45	
	50	CC-TH 70/50	C-90	TSC-80	R-90	
	70	CC-TH 70/70	C-90	TSC-80	R-90	
95	95	CC-TH 70/95	C-90	TSC-80	R-90	
	25	CC-TH 95/25	C-90	TSC-80	R-90	
	35	CC-TH 95/35	C-90	TSC-80	R-90	
	50	CC-TH 95/50	C-90	TSC-80	R-90	
	70	CC-TH 95/70	C-90	TSC-80	R-90	
	95	CC-TH 95/95	C-115	TSC-80	R-90	
120	120	CC-TH 95/120	C-115	TSC-80	R-90	
	25	CC-TH 120/25	C-90	TSC-80	R-90	
	35	CC-TH 120/35	C-90	TSC-80	R-90	
	50	CC-TH 120/50	C-90	TSC-80	R-90	
	70	CC-TH 120/70	C-90	TSC-80	R-90	
	95	CC-TH 120/95	C-115	TSC-80	R-90	
	120	CC-TH 120/120	C-150	TSC-80	R-150	
	150	CC-TH 120/150	C-150	TSC-80	R-150	
	185	CC-TH 120/185	C-200	TSC-80	R-150	

7. Copper aluminothermic welding /

7.1 Cable / Cable

Connection CC-TH (mm²) (2 of 2)

Main	Tap cable	Mould (PART. No.)	Cartridge	Clamp	Scraper	Price key for moulds
150	25	CC-TH 150/25	C-90	TSC-80	R-90	A
	35	CC-TH 150/35	C-115	TSC-80	R-90	
	50	CC-TH 150/50	C-115	TSC-80	R-90	
	70	CC-TH 150/70	C-115	TSC-80	R-90	
	95	CC-TH 150/95	C-150	TSC-80	R-150	
	120	CC-TH 150/120	C-150	TSC-80	R-150	
	150	CC-TH 150/150	C-200	TSC-80	R-150	
	185	CC-TH 150/185	C-200	TSC-80	R-150	
185	240	CC-TH 150/240	C-200	TSC-80	R-150	
	25	CC-TH 185/25	C-115	TSC-80	R-90	
	35	CC-TH 185/35	C-115	TSC-80	R-90	
	50	CC-TH 185/50	C-115	TSC-80	R-90	
	70	CC-TH 185/70	C-150	TSC-80	R-150	
	95	CC-TH 185/95	C-150	TSC-80	R-150	
	120	CC-TH 185/120	C-200	TSC-80	R-150	
	150	CC-TH 185/150	C-200	TSC-80	R-150	
240	185	CC-TH 185/185	C-200	TSC-80	R-150	
	240	CC-TH 185/240	C-250	TSC-80	R-150	
	25	CC-TH 240/25	C-115	TSC-80	R-90	
	35	CC-TH 240/35	C-115	TSC-80	R-90	
	50	CC-TH 240/50	C-150	TSC-80	R-150	
	70	CC-TH 240/70	C-150	TSC-80	R-150	
	95	CC-TH 240/95	C-200	TSC-80	R-150	
	120	CC-TH 240/120	C-200	TSC-80	R-150	
	150	CC-TH 240/150	C-200	TSC-80	R-150	
	185	CC-TH 240/185	C-250	TSC-80	R-150	
	240	CC-TH 240/240	2 x C-150	TSC-80	R-750	

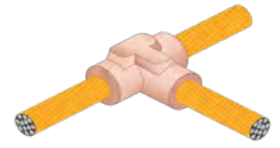

* Possibility of using mini moulds for cartridges C-45 or smaller, with clamp TSC-50 and scraper R-M.

• See mould price key on tariff.

7. Copper aluminothermic welding /

7.1 Cable / Cable

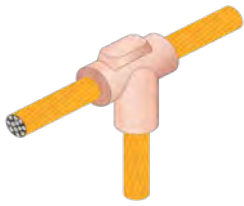
Operating instructions.

Cut run cable and separate (S) 5-6 mm under the centre of the tap hole. But the tap cable against run cable.

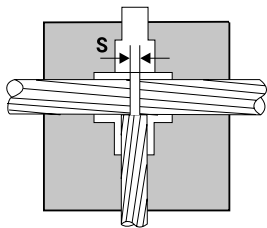
Connection CC-TV (1 of 2)

Dimension cable (mm ²)						Price key for moulds
Main	Tap cable	Mould (PART. No.)	Cartridge	Clamp	Scraper	
25	25	CC-TV 25	C-45*	TSC-80	R-45	A
	35	CC-TV 25/35	C-45*	TSC-80	R-45	
	50	CC-TV 25/50	C-45*	TSC-80	R-45	
35	25	CC-TV 35/25	C-45*	TSC-80	R-45	
	35	CC-TV 35/35	C-45*	TSC-80	R-45	
	50	CC-TV 35/50	C-65	TSC-80	R-45	
50	70	CC-TV 35/70	C-65	TSC-80	R-45	
	25	CC-TV 50/25	C-45*	TSC-80	R-45	
	35	CC-TV 50/35	C-65	TSC-80	R-45	
	50	CC-TV 50/50	C-90	TSC-80	R-90	
70	70	CC-TV 50/70	C-90	TSC-80	R-90	
	95	CC-TV 50/95	C-90	TSC-80	R-90	
	25	CC-TV 70/25	C-65	TSC-80	R-45	
	35	CC-TV 70/35	C-65	TSC-80	R-45	
	50	CC-TV 70/50	C-90	TSC-80	R-90	
	70	CC-TV 70/70	C-90	TSC-80	R-90	
95	95	CC-TV 70/95	C-90	TSC-80	R-90	
	120	CC-TV 70/120	C-115	TSC-80	R-90	
	25	CC-TV 95/25	C-90	TSC-80	R-90	
	35	CC-TV 95/35	C-90	TSC-80	R-90	
	50	CC-TV 95/50	C-90	TSC-80	R-90	
	70	CC-TV 95/70	C-90	TSC-80	R-90	
120	95	CC-TV 95	C-115	TSC-80	R-90	
	120	CC-TV 95/120	C-115	TSC-80	R-90	
	150	CC-TV 95/150	C-115	TSC-80	R-90	
	25	CC-TV 120/25	C-90	TSC-80	R-90	
	35	CC-TV 120/35	C-90	TSC-80	R-90	
	50	CC-TV 120/50	C-90	TSC-80	R-90	
120	70	CC-TV 120/70	C-115	TSC-80	R-90	
	95	CC-TV 120/95	C-115	TSC-80	R-90	
	120	CC-TV 120	C-150	TSC-80	R-150	
	150	CC-TV 120/150	C-150	TSC-80	R-150	
	185	CC-TV 120/185	C-150	TSC-80	R-150	

7. Copper aluminothermic welding /

7.1 Cable / Cable

Connection CC-TV (mm²) (2 of 2)

Main	Tap cable	Mould (PART. No.)	Cartridge	Clamp	Scraper	Price key for moulds
150	25	CC-TH 150/25	C-90	TSC-80	R-90	A
	35	CC-TH 150/35	C-115	TSC-80	R-90	
	50	CC-TH 150/50	C-115	TSC-80	R-90	
	70	CC-TH 150/70	C-115	TSC-80	R-90	
	95	CC-TH 150/95	C-150	TSC-80	R-150	
	120	CC-TH 150/120	C-150	TSC-80	R-150	
	150	CC-TH 150/150	C-200	TSC-80	R-150	
	185	CC-TH 150/185	C-200	TSC-80	R-150	
	240	CC-TH 150/240	C-200	TSC-80	R-150	
185	25	CC-TH 185/25	C-115	TSC-80	R-90	
	35	CC-TH 185/35	C-115	TSC-80	R-90	
	50	CC-TH 185/50	C-115	TSC-80	R-90	
	70	CC-TH 185/70	C-150	TSC-80	R-150	
	95	CC-TH 185/95	C-150	TSC-80	R-150	
	120	CC-TH 185/120	C-200	TSC-80	R-150	
	150	CC-TH 185/150	C-200	TSC-80	R-150	
	185	CC-TH 185/185	C-200	TSC-80	R-150	
	240	CC-TH 185/240	C-250	TSC-80	R-150	
240	25	CC-TH 240/25	C-115	TSC-80	R-90	
	35	CC-TH 240/35	C-115	TSC-80	R-90	
	50	CC-TH 240/50	C-150	TSC-80	R-150	
	70	CC-TH 240/70	C-150	TSC-80	R-150	
	95	CC-TH 240/95	C-200	TSC-80	R-150	
	120	CC-TH 240/120	C-200	TSC-80	R-150	
	150	CC-TH 240/150	C-200	TSC-80	R-150	
	185	CC-TH 240/185	C-250	TSC-80	R-150	
	240	CC-TH 240/240	2 x C-150	TSC-80	R-750	

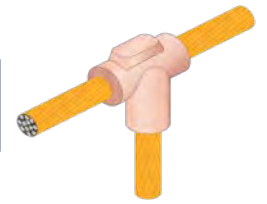

* Possibility of using mini moulds for cartridges C-45 or smaller, with clamp TSC-50 and scraper R-M.

• See mould price key on tariff.



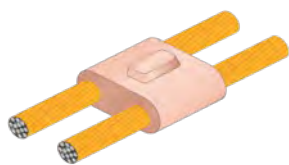

7. Copper aluminothermic welding /

7.1 Cable / Cable

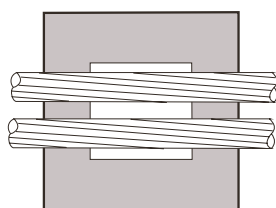

Operating instructions.
Place cables according to the sketch below.



Connection CC-DPH (1 of 2)						
Dimension cable (mm ²)						Price key for moulds
Main	Tap cable	Mould (PART. No.)	Cartridge	Clamp	Scraper	
25	25	CC-DPH 25/25	C-65	TSC-80	R-45	A
	35	CC-DPH 25/35	C-65	TSC-80	R-45	
	50	CC-DPH 25/50	C-90	TSC-80	R-90	
	70	CC-DPH 25/70	C-90	TSC-80	R-90	
	95	CC-DPH 25/95	C-90	TSC-80	R-90	
35	120	CC-DPH 25/120	C-115	TSC-80	R-90	
	25	CC-DPH 35/25	C-65	TSC-80	R-45	
	35	CC-DPH 35/35	C-90	TSC-80	R-90	
	50	CC-DPH 35/50	C-90	TSC-80	R-90	
	70	CC-DPH 35/70	C-115	TSC-80	R-90	
	95	CC-DPH 35/95	C-115	TSC-80	R-90	
50	120	CC-DPH 35/120	C-115	TSC-80	R-90	
	150	CC-DPH 35/150	C-115	TSC-80	R-90	
	25	CC-DPH 50/25	C-90	TSC-80	R-90	
	35	CC-DPH 50/35	C-90	TSC-80	R-90	
	50	CC-DPH 50/50	C-90	TSC-80	R-90	
	70	CC-DPH 50/70	C-115	TSC-80	R-90	
	95	CC-DPH 50/95	C-115	TSC-80	R-90	
70	120	CC-DPH 50/120	C-150	TSC-80	R-150	
	150	CC-DPH 50/150	C-150	TSC-80	R-150	
	185	CC-DPH 50/185	C-150	TSC-80	R-150	
	25	CC-DPH 70/25	C-90	TSC-80	R-90	
	35	CC-DPH 70/35	C-115	TSC-80	R-90	
	50	CC-DPH 70/50	C-115	TSC-80	R-90	
	70	CC-DPH 70/70	C-115	TSC-80	R-90	
	95	CC-DPH 70/95	C-150	TSC-80	R-150	
	120	CC-DPH 70/120	C-150	TSC-80	R-150	
95	150	CC-DPH 70/150	C-200	TSC-80	R-150	
	185	CC-DPH 70/185	C-200	TSC-80	R-150	
	240	CC-DPH 70/240	C-250	TSC-80	R-150	
	25	CC-DPH 95/25	C-90	TSC-80	R-90	
	35	CC-DPH 95/35	C-115	TSC-80	R-90	
	50	CC-DPH 95/50	C-115	TSC-80	R-90	
	70	CC-DPH 95/70	C-150	TSC-80	R-150	
	95	CC-DPH 95/95	C-150	TSC-80	R-150	
95	120	CC-DPH 95/120	C-200	TSC-80	R-150	
	150	CC-DPH 95/150	C-200	TSC-80	R-150	
	185	CC-DPH 95/185	C-200	TSC-80	R-150	
	240	CC-DPH 95/240	2 x C-150	TSC-100	R-750	

7. Copper aluminothermic welding /

7.1 Cable / Cable

Connection CC-DPH (mm²) (2 of 2)

Main	Tap cable	Mould (PART. No.)	Cartridge	Clamp	Scraper	Price key for moulds
120	25	CC-DPH 120/25	C-115	TSC-80	R-90	A
	35	CC-DPH 120/35	C-115	TSC-80	R-90	
	50	CC-DPH 120/50	C-150	TSC-80	R-150	
	70	CC-DPH 120/70	C-150	TSC-80	R-150	
	95	CC-DPH 120/95	C-200	TSC-80	R-150	
	120	CC-DPH 120/120	C-200	TSC-80	R-150	
	150	CC-DPH 120/150	C-200	TSC-80	R-150	
	185	CC-DPH 120/185	C-250	TSC-80	R-150	C
	240	CC-DPH 120/240	2 x C-150	TSC-80	R-750	E
150	35	CC-DPH 150/35	C-150	TSC-80	R-150	A
	50	CC-DPH 150/50	C-200	TSC-80	R-150	
	70	CC-DPH 150/70	C-200	TSC-80	R-150	
	95	CC-DPH 150/95	C-200	TSC-80	R-150	
	120	CC-DPH 150/120	C-250	TSC-80	R-150	
	150	CC-DPH 150/150	C-250	TSC-80	R-150	
	185	CC-DPH 150/185	C-250	TSC-80	R-750	
	240	CC-DPH 150/240	2 x C-200	TSC-100	R-750	
185	35	CC-DPH 185/35	C-200	TSC-80	R-150	C
	50	CC-DPH 185/50	C-250	TSC-80	R-150	
	70	CC-DPH 185/70	C-250	TSC-80	R-150	
	95	CC-DPH 185/95	C-200	TSC-80	R-150	
	120	CC-DPH 185/120	C-250	TSC-80	R-150	
	150	CC-DPH 185/150	C-250	TSC-80	R-150	
	185	CC-DPH 185/185	C-250	TSC-80	R-150	
	240	CC-DPH 185/240	2 x C-150	TSC-100	R-750	
240	50	CC-DPH 240/50	C-200	TSC-100	R-150	E
	70	CC-DPH 240/70	C-250	TSC-100	R-150	
	95	CC-DPH 240/95	2 x C-150	TSC-100	R-750	
	120	CC-DPH 240/120	2 x C-150	TSC-100	R-750	
	150	CC-DPH 240/150	2 x C-200	TSC-100	R-750	
	185	CC-DPH 240/185	2 x C-200	TSC-100	R-750	
	240	CC-DPH 240/240	2 x C-250	TSC-100	R-750	

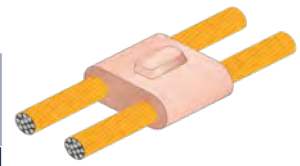

• See mould price key on tariff.

7. Copper aluminothermic welding /
 7.1 Cable / Cable

Operating instructions.

Cut the larger cable and butt the ends against the smaller one.

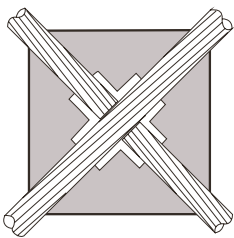
Connection CC-X (mm²) (1 of 2)

Dimension cable (mm ²)						Price key for moulds
Main	Tap cable	Mould (PART. No.)	Cartridge	Clamp	Scraper	
25	25	CC-X 25/25	C-65	TSC-80	R-45	A
	35	CC-X 25/35	C-90	TSC-80	R-45	
	50	CC-X 25/50	C-90	TSC-80	R-90	
	70	CC-X 25/70	C-90	TSC-80	R-90	
	95	CC-X 25/95	C-90	TSC-80	R-90	
35	120	CC-X 25/120	C-115	TSC-80	R-90	
	25	CC-X 35/25	C-90	TSC-80	R-90	
	35	CC-X 35/35	C-90	TSC-80	R-90	
	50	CC-X 35/50	C-90	TSC-80	R-90	
	70	CC-X 35/70	C-115	TSC-80	R-90	
	95	CC-X 35/95	C-115	TSC-80	R-90	
50	120	CC-X 35/120	C-115	TSC-80	R-90	
	150	CC-X 35/150	C-150	TSC-80	R-90	
	25	CC-X 50/25	C-90	TSC-80	R-90	
	35	CC-X 50/35	C-90	TSC-80	R-90	
	50	CC-X 50/50	C-90	TSC-80	R-90	
	70	CC-X 50/70	C-115	TSC-80	R-90	
	95	CC-X 50/95	C-115	TSC-80	R-90	
70	120	CC-X 50/120	C-150	TSC-80	R-150	
	150	CC-X 50/150	C-150	TSC-80	R-150	
	185	CC-X 50/185	C-250	TSC-80	R-150	
	25	CC-X 70/25	C-90	TSC-80	R-90	
	35	CC-X 70/35	C-115	TSC-80	R-90	
	50	CC-X 70/50	C-115	TSC-80	R-90	
	70	CC-X 70/70	C-115	TSC-80	R-90	
	95	CC-X 70/95	C-150	TSC-80	R-150	
	120	CC-X 70/120	C-150	TSC-80	R-150	
95	150	CC-X 70/150	C-200	TSC-80	R-150	
	185	CC-X 70/185	C-200	TSC-80	R-150	
	240	CC-X 70/240	C-250	TSC-80	R-150	
	25	CC-X 95/25	C-90	TSC-80	R-90	
	35	CC-X 95/35	C-115	TSC-80	R-90	
	50	CC-X 95/50	C-115	TSC-80	R-90	
	70	CC-X 95/70	C-150	TSC-80	R-150	
	95	CC-X 95/95	C-150	TSC-80	R-150	
	120	CC-X 95/120	C-200	TSC-80	R-150	
	150	CC-X 95/150	C-200	TSC-80	R-150	
	185	CC-X 95/185	C-250	TSC-80	R-150	
	240	CC-X 95/240	2 x C-150	TSC-100	R-750	

7. Copper aluminothermic welding /

7.1 Cable / Cable

Connection CC-X (mm²) (2 of 2)

Main	Tap cable	Mould (PART. No.)	Cartridge	Clamp	Scraper	Price key for moulds
120	25	CC-X 120/25	C-115	TSC-80	R-90	A
	35	CC-X 120/35	C-115	TSC-80	R-90	
	50	CC-X 120/50	C-150	TSC-80	R-150	
	70	CC-X 120/70	C-150	TSC-80	R-150	
	95	CC-X 120/95	C-200	TSC-80	R-150	
	120	CC-X 120/120	C-200	TSC-80	R-150	
	150	CC-X 120/150	C-200	TSC-80	R-150	
	185	CC-X 120/185	C-250	TSC-80	R-150	
	240	CC-X 120/240	2 x C-150	TSC-100	R-750	E
150	35	CC-X 150/35	C-150	TSC-80	R-90	A
	50	CC-X 150/50	C-150	TSC-80	R-150	
	70	CC-X 150/70	C-200	TSC-80	R-150	
	95	CC-X 150/95	C-200	TSC-80	R-150	
	120	CC-X 150/120	C-200	TSC-80	R-150	
	150	CC-X 150/150	C-250	TSC-80	R-150	
	185	CC-X 150/185	C-250	TSC-80	R-150	
	240	CC-X 150/240	2 x C-200	TSC-100	R-750	E
185	35	CC-X 185/35	C-200	TSC-80	R-150	A
	50	CC-X 185/50	C-250	TSC-80	R-150	
	70	CC-X 185/70	C-250	TSC-80	R-150	
	95	CC-X 185/95	C-250	TSC-80	R-150	
	120	CC-X 185/120	C-250	TSC-80	R-150	
	150	CC-X 185/150	C-250	TSC-80	R-150	
	185	CC-X 185/185	C-250	TSC-80	R-150	
	240	CC-X 185/240	2 x C-200	TSC-100	R-750	
240	50	CC-X 240/50	C-200	TSC-100	R-750	E
	70	CC-X 240/70	C-250	TSC-100	R-750	
	95	CC-X 240/95	2 x C-150	TSC-100	R-750	
	120	CC-X 240/120	2 x C-150	TSC-100	R-750	
	150	CC-X 240/150	2 x C-200	TSC-100	R-750	
	185	CC-X 240/185	2 x C-200	TSC-100	R-750	
	240	CC-X 240/240	2 x C-250	TSC-100	R-750	

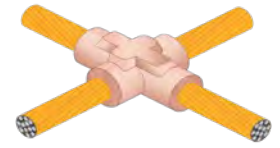

• See mould price key on tariff.

7. Copper aluminothermic welding /

7.1 Cable / Cable

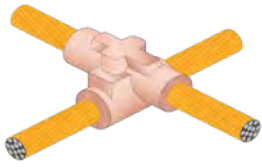

Operating instructions.
Place the largest cable over the smallest. Demould carefully not to damage the mould.

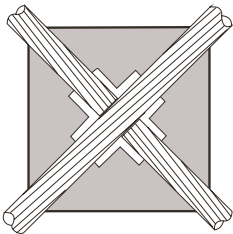
Connection CC-XS (1 of 2)

Dimension cable (mm ²)						Price key for moulds
Main	Tap cable	Mould (PART. No.)	Cartridge	Clamp	Scraper	
25	25	CC-XS 25/25	C-90	TSC-80	R-90	B
	35	CC-XS 25/35	C-115	TSC-80	R-90	
	50	CC-XS 25/50	C-115	TSC-80	R-90	
	70	CC-XS 25/70	C-115	TSC-80	R-90	
	95	CC-XS 25/95	C-150	TSC-80	R-150	
	120	CC-XS 25/120	C-150	TSC-80	R-150	
	150	CC-XS 25/150	C-200	TSC-80	R-150	
	185	CC-XS 25/185	C-200	TSC-80	R-150	
35	240	CC-XS 25/240	C-200	TSC-80	R-150	
	25	CC-XS 35/25	C-115	TSC-80	R-90	
	35	CC-XS 35/35	C-115	TSC-80	R-90	
	50	CC-XS 35/50	C-115	TSC-80	R-90	
	70	CC-XS 35/70	C-150	TSC-80	R-150	
	95	CC-XS 35/95	C-200	TSC-80	R-150	
	120	CC-XS 35/120	C-200	TSC-80	R-150	
	150	CC-XS 35/150	C-200	TSC-80	R-150	
50	185	CC-XS 35/185	C-200	TSC-80	R-150	
	240	CC-XS 35/240	C-250	TSC-80	R-150	
	25	CC-XS 50/25	C-115	TSC-80	R-90	
	35	CC-XS 50/35	C-115	TSC-80	R-90	
	50	CC-XS 50/50	C-150	TSC-80	R-150	
	70	CC-XS 50/70	C-200	TSC-80	R-150	
	95	CC-XS 50/95	C-250	TSC-80	R-150	
	120	CC-XS 50/120	C-200	TSC-80	R-150	
70	150	CC-XS 50/150	C-250	TSC-80	R-150	
	185	CC-XS 50/185	C-250	TSC-80	R-150	
	240	CC-XS 50/240	2 x C-150	TSC-80	R-750	
	35	CC-XS 70/35	C-150	TSC-80	R-150	
	50	CC-XS 70/50	C-200	TSC-80	R-150	
	70	CC-XS 70/70	C-200	TSC-80	R-150	
	95	CC-XS 70/95	C-250	TSC-80	R-150	
	120	CC-XS 70/120	C-250	TSC-80	R-150	
	150	CC-XS 70/150	2 x C-150	TSC-100	R-750	
	185	CC-XS 70/185	2 x C-200	TSC-100	R-750	
	240	CC-XS 70/240	2 x C-200	TSC-100	R-750	
						E

7. Copper aluminothermic welding /

7.1 Cable / Cable

Connection CC-XS (mm²) (2 of 2)

Main	Tap cable	Mould (PART. No.)	Cartridge	Clamp	Scraper	Price key for moulds	
95	35	CC-XS 95/35	C-200	TSC-80	R-150	B	
	50	CC-XS 95/50	C-250	TSC-80	R-150		
	70	CC-XS 95/70	C-250	TSC-80	R-150		
	95	CC-XS 95/95	C-250	TSC-80	R-150		
	120	120	CC-XS 95/120	2 x C-150	TSC-100	R-750	E
		150	CC-XS 95/150	2 x C-150	TSC-100	R-750	
		185	CC-XS 95/185	2 x C-200	TSC-100	R-750	
		240	CC-XS 95/240	2 x C-200	TSC-100	R-750	
50		CC-XS 120/50	C-200	TSC-100	R-150	B	
70	CC-XS 120/70	C-250	TSC-100	R-150			
150	95	CC-XS 120/95	2 x C-150	TSC-100	R-750	E	
	120	CC-XS 120/120	2 x C-150	TSC-100	R-750		
	150	CC-XS 120/150	2 x C-200	TSC-100	R-750		
	185	CC-XS 120/185	2 x C-250	TSC-100	R-750		
	240	CC-XS 120/240	2 x C-250	TSC-100	R-750		
	50	CC-XS 150/50	C-250	TSC-80	R-150		B
	70	CC-XS 150/70	2 x C-150	TSC-100	R-750		
185	95	CC-XS 150/95	2 x C-150	TSC-100	R-750	E	
	120	CC-XS 150/120	2 x C-200	TSC-100	R-750		
	150	CC-XS 150/150	2 x C-200	TSC-100	R-750		
	185	CC-XS 150/185	2 x C-250	TSC-100	R-750		
	240	CC-XS 150/240	2 x C-250	TSC-100	R-750		
	70	CC-XS 185/70	2x C-200	TSC-100	R-750		
	95	CC-XS 185/95	2 x C-200	TSC-100	R-750		
	120	CC-XS 185/120	2 x C-250	TSC-100	R-750		
150	CC-XS 185/150	2 x C-250	TSC-100	R-750			
185	CC-XS 185/185	2 x C-250	TSC-100	R-750			

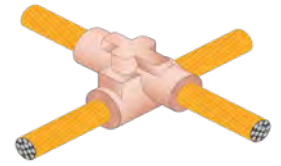

• See mould price key on tariff.

Operating instructions.

Place end of cable at the axis of the tap hole and rod butted against the cable. Use a clamp-prod below mould to support it.

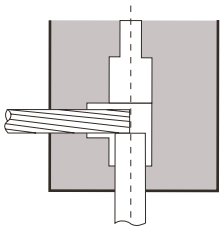

Connection CP-AR						
Dimension						Price key for moulds
Rod	Cable (mm ²)	Mould (PART. No.)	Cartridge	Clamp	Scraper	
143	25	CP-AR 143/25	C-65	TSC-80	R-45	A
	35	CP-AR 143/35	C-65	TSC-80	R-45	
	50	CP-AR 143/50	C-90	TSC-80	R-90	
	70	CP-AR 143/70	C-90	TSC-80	R-90	
	95	CP-AR 143/95	C-90	TSC-80	R-90	
	120	CP-AR 143/120	C-90	TSC-80	R-90	
	150	CP-AR 143/150	C-115	TSC-80	R-90	
	185	CP-AR 143/185	C-115	TSC-80	R-90	
	240	CP-AR 143/240	C-150	TSC-80	R-150	
146	25	CP-AR 146/25	C-65	TSC-80	R-45	
	35	CP-AR 146/35	C-65	TSC-80	R-45	
	50	CP-AR 146/50	C-90	TSC-80	R-90	
	70	CP-AR 146/70	C-90	TSC-80	R-90	
	95	CP-AR 146/95	C-90	TSC-80	R-90	
	120	CP-AR 146/120	C-90	TSC-80	R-90	
	150	CP-AR 146/150	C-115	TSC-80	R-90	
	185	CP-AR 146/185	C-115	TSC-80	R-90	
	240	CP-AR 146/240	C-150	TSC-80	R-150	
58	25	CP-AR 58/25	C-65	TSC-80	R-45	
	35	CP-AR 58/35	C-65	TSC-80	R-45	
	50	CP-AR 58/50	C-90	TSC-80	R-90	
	70	CP-AR 58/70	C-90	TSC-80	R-90	
	95	CP-AR 58/95	C-90	TSC-80	R-90	
	120	CP-AR 58/120	C-90	TSC-80	R-90	
	150	CP-AR 58/150	C-115	TSC-80	R-90	
	185	CP-AR 58/185	C-115	TSC-80	R-90	
	240	CP-AR 58/240	C-150	TSC-80	R-150	
183	25	CP-AR 183/25	C-90	TSC-80	R-90	
	35	CP-AR 183/35	C-90	TSC-80	R-90	
	50	CP-AR 183/50	C-90	TSC-80	R-90	
	70	CP-AR 183/70	C-90	TSC-80	R-90	
	95	CP-AR 183/95	C-90	TSC-80	R-90	
	120	CP-AR 183/120	C-90	TSC-80	R-90	
	150	CP-AR 183/150	C-115	TSC-80	R-90	
	185	CP-AR 183/185	C-115	TSC-80	R-90	
	240	CP-AR 183/240	C-150	TSC-80	R-150	
34	25	CP-AR 34/25	C-90	TSC-80	R-90	
	35	CP-AR 34/35	C-90	TSC-80	R-90	
	50	CP-AR 34/50	C-90	TSC-80	R-90	
	70	CP-AR 34/70	C-90	TSC-80	R-90	
	95	CP-AR 34/95	C-90	TSC-80	R-90	
	120	CP-AR 34/120	C-90	TSC-80	R-90	
	150	CP-AR 34/150	C-115	TSC-80	R-90	
	185	CP-AR 34/185	C-115	TSC-80	R-90	
	240	CP-AR 34/240	C-150	TSC-80	R-150	

• See mould price key on tariff.

7. Copper aluminothermic welding /

7.2 Cable / earth rod

Connection CP-T

Dimension						Price key for moulds
Rod	Cable (mm ²)	Mould (PART. No.)	Cartridge	Clamp	Scraper	
143	25	CP-T 143/25	C-90	TSC-80	R-90	A
	35	CP-T 143/35	C-90	TSC-80	R-90	
	50	CP-T 143/50	C-90	TSC-80	R-90	
	70	CP-T 143/70	C-115	TSC-80	R-90	
	95	CP-T 143/95	C-115	TSC-80	R-90	
	120	CP-T 143/120	C-150	TSC-80	R-150	
	150	CP-T 143/150	C-200	TSC-80	R-150	
	185	CP-T 143/185	C-200	TSC-80	R-150	
240	CP-T 143/240	C-250	TSC-80	R-150		
146	25	CP-T 146/25	C-90	TSC-80	R-90	
	35	CP-T 146/35	C-90	TSC-80	R-90	
	50	CP-T 146/50	C-90	TSC-80	R-90	
	70	CP-T 146/70	C-115	TSC-80	R-90	
	95	CP-T 146/95	C-115	TSC-80	R-90	
	120	CP-T 146/120	C-150	TSC-80	R-150	
	150	CP-T 146/150	C-200	TSC-80	R-150	
	185	CP-T 146/185	C-200	TSC-80	R-150	
240	CP-T 146/240	C-250	TSC-80	R-150		
58	25	CP-T 58/25	C-90	TSC-80	R-90	
	35	CP-T 58/35	C-90	TSC-80	R-90	
	50	CP-T 58/50	C-90	TSC-80	R-90	
	70	CP-T 58/70	C-115	TSC-80	R-90	
	95	CP-T 58/95	C-115	TSC-80	R-90	
	120	CP-T 58/120	C-150	TSC-80	R-150	
	150	CP-T 58/150	C-200	TSC-80	R-150	
	185	CP-T 58/185	C-200	TSC-80	R-150	
240	CP-T 58/240	C-250	TSC-80	R-150		
183	25	CP-T 183/25	C-90	TSC-80	R-90	
	35	CP-T 183/35	C-90	TSC-80	R-90	
	50	CP-T 183/50	C-115	TSC-80	R-90	
	70	CP-T 183/70	C-115	TSC-80	R-90	
	95	CP-T 183/95	C-115	TSC-80	R-90	
	120	CP-T 183/120	C-150	TSC-80	R-150	
	150	CP-T 183/150	C-200	TSC-80	R-150	
	185	CP-T 183/185	C-200	TSC-80	R-150	
240	CP-T 183/240	C-250	TSC-80	R-150		
34	25	CP-T 34/25	C-90	TSC-80	R-90	
	35	CP-T 34/35	C-90	TSC-80	R-90	
	50	CP-T 34/50	C-115	TSC-80	R-90	
	70	CP-T 34/70	C-115	TSC-80	R-90	
	95	CP-T 34/95	C-115	TSC-80	R-90	
	120	CP-T 34/120	C-150	TSC-80	R-150	
	150	CP-T 34/150	C-200	TSC-80	R-150	
	185	CP-T 34/185	C-200	TSC-80	R-150	
240	CP-AR 34/240	C-250	TSC-80	R-150		

Operating instructions.

Cut run cable and separate (S) 5-6 mm under the centre of the tap hole. But the tap cable against run cable.

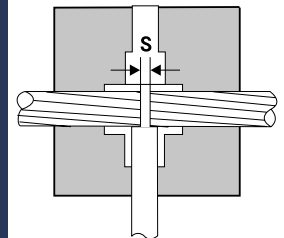

• See mould price key on tariff.

7. Copper aluminothermic welding /

7.2 Cable / earth rod



Operating instructions.
 Insert cable into the mould and secure it to rod with backing plate attachment. Use another clamp on rod below mould.

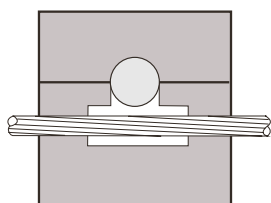

Connection CP-TS						
Dimension						
Rod	Cable (mm ²)	Mould (PART. No.)	Cartridge	Clamp	Scraper	Price key for moulds
143	25	CP-TS 143/25	C-90	TSC-80	R-90	D
	35	CP-TS 143/35	C-90	TSC-80	R-90	
	50	CP-TS 143/50	C-115	TSC-80	R-90	
	70	CP-TS 143/70	C-115	TSC-80	R-90	
	95	CP-TS 143/95	C-115	TSC-80	R-90	
	120	CP-TS 143/120	C-150	TSC-80	R-150	
	150	CP-TS 143/150	C-150	TSC-80	R-150	
	185	CP-TS 143/185	C-250	TSC-80	R-150	H
	240	CP-TS 143/240	2 x C-200	TSC-80	R-150	H
146	25	CP-TS 146/25	C-90	TSC-80	R-90	D
	35	CP-TS 146/35	C-90	TSC-80	R-90	
	50	CP-TS 146/50	C-115	TSC-80	R-90	
	70	CP-TS 146/70	C-115	TSC-80	R-90	
	95	CP-TS 146/95	C-115	TSC-80	R-90	
	120	CP-TS 146/120	C-150	TSC-80	R-150	
	150	CP-TS 146/150	C-150	TSC-80	R-150	
	185	CP-TS 146/185	C-250	TSC-80	R-150	H
	240	CP-TS 146/240	2 x C-200	TSC-80	R-150	H
58	25	CP-TS 58/25	C-90	TSC-80	R-90	D
	35	CP-TS 58/35	C-90	TSC-80	R-90	
	50	CP-TS 58/50	C-115	TSC-80	R-90	
	70	CP-TS 58/70	C-115	TSC-80	R-90	
	95	CP-TS 58/95	C-115	TSC-80	R-90	
	120	CP-TS 58/120	C-150	TSC-80	R-150	
	150	CP-TS 58/150	C-150	TSC-80	R-150	
	185	CP-TS 58/185	C-250	TSC-80	R-150	H
	240	CP-TS 58/240	2 x C-200	TSC-80	R-150	H
183	25	CP-TS 183/25	C-90	TSC-80	R-90	D
	35	CP-TS 183/35	C-90	TSC-80	R-90	
	50	CP-TS 183/50	C-115	TSC-80	R-90	
	70	CP-TS 183/70	C-150	TSC-80	R-150	
	95	CP-TS 183/95	C-150	TSC-80	R-150	
	120	CP-TS 183/120	C-200	TSC-80	R-150	
	150	CP-TS 183/150	C-250	TSC-80	R-150	
	185	CP-TS 183/185	2 x C-150	TSC-80	R-750	H
	240	CP-TS 183/240	2 x C-250	TSC-80	R-750	H
34	25	CP-TS 34/25	C-90	TSC-80	R-90	D
	35	CP-TS 34/35	C-90	TSC-80	R-90	
	50	CP-TS 34/50	C-115	TSC-80	R-90	
	70	CP-TS 34/70	C-150	TSC-80	R-150	
	95	CP-TS 34/95	C-150	TSC-80	R-150	
	120	CP-TS 34/120	C-200	TSC-80	R-150	
	150	CP-TS 34/150	C-250	TSC-80	R-150	
	185	CP-TS 34/185	2 x C-150	TSC-80	R-750	H
	240	CP-TS 34/240	2 x C-250	TSC-80	R-750	H

• See mould price key on tariff.

7. Copper aluminothermic welding /

7.2 Cable / earth rod

Connection CP-V

Dimension						Price key for moulds
Rod	Cable (mm ²)	Mould (PART. No.)	Cartridge	Clamp	Scraper	
143	25	CP-V 143/25	C-65	TSC-80	R-45	B
	35	CP-V 143/35	C-65	TSC-80	R-45	D
	50	CP-V 143/50	C-90	TSC-80	R-90	
	70	CP-V 143/70	C-90	TSC-80	R-90	
	95	CP-V 143/95	C-90	TSC-80	R-90	
	120	CP-V 143/120	C-90	TSC-80	R-90	
	150	CP-V 143/150	C-115	TSC-80	R-90	
	185	CP-V 143/185	C-115	TSC-80	R-90	
240	CP-V 143/240	C-150	TSC-80	R-150		
146	25	CP-V 146/25	C-65	TSC-80	R-45	B
	35	CP-V 146/35	C-65	TSC-80	R-45	D
	50	CP-V 146/50	C-90	TSC-80	R-90	
	70	CP-V 146/70	C-90	TSC-80	R-90	
	95	CP-V 146/95	C-90	TSC-80	R-90	
	120	CP-V 146/120	C-90	TSC-80	R-90	
	150	CP-V 146/150	C-115	TSC-80	R-90	
	185	CP-V 146/185	C-115	TSC-80	R-90	
240	CP-V 146/240	C-150	TSC-80	R-150		
58	25	CP-V 58/25	C-65	TSC-80	R-45	B
	35	CP-V 58/35	C-65	TSC-80	R-45	D
	50	CP-V 58/50	C-90	TSC-80	R-90	
	70	CP-V 58/70	C-90	TSC-80	R-90	
	95	CP-V 58/95	C-90	TSC-80	R-90	
	120	CP-V 58/120	C-90	TSC-80	R-90	
	150	CP-V 58/150	C-115	TSC-80	R-90	
	185	CP-V 58/185	C-115	TSC-80	R-90	
240	CP-V 58/240	C-150	TSC-80	R-150		
183	25	CP-V 183/25	C-90	TSC-80	R-90	D
	35	CP-V 183/35	C-90	TSC-80	R-90	
	50	CP-V 183/50	C-90	TSC-80	R-90	
	70	CP-V 183/70	C-90	TSC-80	R-90	
	95	CP-V 183/95	C-90	TSC-80	R-90	
	120	CP-V 183/120	C-90	TSC-80	R-90	
	150	CP-V 183/150	C-115	TSC-80	R-90	
	185	CP-V 183/185	C-115	TSC-80	R-90	
240	CP-V 183/240	C-150	TSC-80	R-150		
34	25	CP-V 34/25	C-90	TSC-80	R-90	D
	35	CP-V 34/35	C-90	TSC-80	R-90	
	50	CP-V 34/50	C-90	TSC-80	R-90	
	70	CP-V 34/70	C-90	TSC-80	R-90	
	95	CP-V 34/95	C-90	TSC-80	R-90	
	120	CP-V 34/120	C-90	TSC-80	R-90	
	150	CP-V 34/150	C-115	TSC-80	R-90	
	185	CP-V 34/185	C-115	TSC-80	R-90	
240	CP-V 34/240	C-150	TSC-80	R-150		



Operating instructions.
Separate rod and cable (S) 5-6 mm. At the axis of the tap hole. Use a clamp on rod below mould.

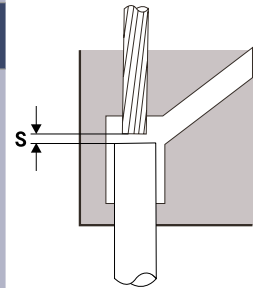



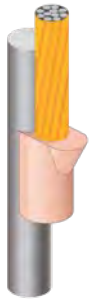

• See mould price key on tariff.

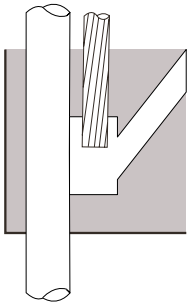

Operating instructions.
 Insert cable until the axis of the tap hole. Use a clamp on rod below mould.







Connection CP-VS						
Dimension						
Rod	Cable (mm ²)	Mould (PART. No.)	Cartridge	Clamp	Scraper	Price key for moulds
143	25	CP-VS 143/25	C-90	TSC-80	R-90	D
	35	CP-VS 143/35	C-90	TSC-80	R-90	
	50	CP-VS 143/50	C-115	TSC-80	R-90	
	70	CP-VS 143/70	C-150	TSC-80	R-150	
	95	CP-VS 143/95	C-150	TSC-80	R-150	
	120	CP-VS 143/120	C-200	TSC-80	R-150	
	150	CP-VS 143/150	C-250	TSC-80	R-150	
	185	CP-VS 143/185	2 x C-150	TSC-80	R-150	
146	240	CP-VS 143/240	2 x C-250	TSC-80	R-150	I
	25	CP-VS 146/25	C-90	TSC-80	R-90	D
	35	CP-VS 146/35	C-90	TSC-80	R-90	
	50	CP-VS 146/50	C-115	TSC-80	R-90	
	70	CP-VS 146/70	C-150	TSC-80	R-150	
	95	CP-VS 146/95	C-150	TSC-80	R-150	
	120	CP-VS 146/120	C-200	TSC-80	R-150	
	150	CP-VS 146/150	C-250	TSC-80	R-150	
185	CP-VS 146/185	2 x C-150	TSC-80	R-150	I	
58	240	CP-VS 146/240	2 x C-250	TSC-80	R-150	I
	25	CP-VS 58/25	C-90	TSC-80	R-90	D
	35	CP-VS 58/35	C-90	TSC-80	R-90	
	50	CP-VS 58/50	C-115	TSC-80	R-90	
	70	CP-VS 58/70	C-150	TSC-80	R-90	
	95	CP-VS 58/95	C-200	TSC-80	R-90	
	120	CP-VS 58/120	C-200	TSC-80	R-150	
	150	CP-VS 58/150	C-250	TSC-80	R-150	
185	CP-VS 58/185	2 x C-150	TSC-80	R-150	I	
183	240	CP-VS 58/240	2 x C-200	TSC-80	R-150	I
	25	CP-VS 183/25	C-90	TSC-80	R-90	D
	35	CP-VS 183/35	C-90	TSC-80	R-90	
	50	CP-VS 183/50	C-115	TSC-80	R-90	
	70	CP-VS 183/70	C-150	TSC-80	R-150	
	95	CP-VS 183/95	C-200	TSC-80	R-150	
	120	CP-VS 183/120	C-200	TSC-80	R-150	
	150	CP-VS 183/150	C-250	TSC-80	R-150	
185	CP-VS 183/185	2 x C-150	TSC-80	R-150	I	
34	240	CP-VS 183/240	2 x C-200	TSC-80	R-150	I
	25	CP-VS 34/25	C-90	TSC-80	R-90	D
	35	CP-VS 34/35	C-90	TSC-80	R-90	
	50	CP-VS 34/50	C-115	TSC-80	R-90	
	70	CP-VS 34/70	C-150	TSC-80	R-150	
	95	CP-VS 34/95	C-200	TSC-80	R-150	
	120	CP-VS 34/120	C-200	TSC-80	R-150	
	150	CP-VS 34/150	C-250	TSC-80	R-150	
185	CP-VS 34/185	2 x C-150	TSC-80	R-150	I	
	240	CP-VS 34/240	2 x C-200	TSC-80	R-150	I

• See mould price key on tariff.

7. Copper aluminothermic welding /

7.3 Earth rod / earth rod

Connection PP-V

Dimension					Price key for moulds
Rod	Mould (PART. No.)	Cartridge	Clamp	Scraper	D
143	PP-V 143	C-200	TSC-80	R-150	
146	PP-V 146	C-200	TSC-80	R-150	
58	PP-V 58	C-200	TSC-80	R-150	
183	PP-V 183	2 x C-150	TSC-80	R-150	
34	PP-V 34	2 x C-150	TSC-80	R-150	





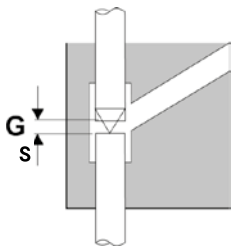

• See mould price key on tariff.



Operating instructions.

Place tip point of the rods in the centre of the tap rod. If they do not have a point, separate them (S) 10 mm. Use a clamp on lower rod below mould.



Connection CR-XS						
Dimension						Price key for moulds
Re-bar (mm)	Cable (mm ²)	Mould (PART. No.)	Cartridge	Clamp	Scraper	
10	25	CR-XS 10/25	C-90	TSC-80	R-90	B
	35	CR-XS 10/35	C-90	TSC-80	R-90	
	50	CR-XS 10/50	C-115	TSC-80	R-90	
	70	CR-XS 10/70	C-150	TSC-80	R-150	
	95	CR-XS 10/95	C-150	TSC-80	R-150	
16	25	CR-XS 16/25	C-115	TSC-100	R-90	E
	35	CR-XS 16/35	C-115	TSC-100	R-90	
	50	CR-XS 16/50	C-150	TSC-100	R-150	
	70	CR-XS 16/70	C-150	TSC-100	R-150	
	95	CR-XS 16/95	C-200	TSC-100	R-150	
	120	CR-XS 16/120	C-200	TSC-100	R-150	
	150	CR-XS 16/150	C-200	TSC-100	R-150	
20	25	CR-XS 20/25	C-115	TSC-100	R-90	E
	35	CR-XS 20/35	C-150	TSC-100	R-150	
	50	CR-XS 20/50	C-150	TSC-100	R-150	
	70	CR-XS 20/70	C-200	TSC-100	R-150	
	95	CR-XS 20/95	C-200	TSC-100	R-150	
	120	CR-XS 20/120	C-250	TSC-100	R-150	
	150	CR-XS 20/150	C-250	TSC-100	R-150	
	185	CR-XS 20/185	C-250	TSC-100	R-150	
	240	CR-XS 20/240	2 x C-150	TSC-100	R-750	

• See mould price key on tariff.

Use sealing paste.

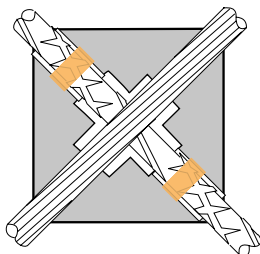

Operating instructions.

Seal the re-bar with paste on both sides of the weld cavity. Place cable over the top of rebar.

7. Copper aluminothermic welding /

7.4 Cable / Re-bar

Connection CR-TH

Dimension						Price key for moulds
Re-bar (mm)	Cable (mm ²)	Mould (PART. No.)	Cartridge	Clamp	Scraper	
10	25	CR-TH 10/25	C-90	TSC-80	R-90	A
	35	CR-TH 10/35	C-90	TSC-80	R-90	
	50	CR-TH 10/50	C-115	TSC-80	R-90	
	70	CR-TH 10/70	C-115	TSC-80	R-90	
	95	CR-TH 10/95	C-150	TSC-80	R-150	
16	25	CR-TH 16/25	C-115	TSC-80	R-90	
	35	CR-TH 16/35	C-150	TSC-80	R-150	
	50	CR-TH 16/50	C-150	TSC-80	R-150	
	70	CR-TH 16/70	C-150	TSC-80	R-150	
	95	CR-TH 16/95	C-200	TSC-80	R-150	
	120	CR-TH 16/120	C-200	TSC-80	R-150	
	150	CR-TH 16/150	C-250	TSC-80	R-150	
20	25	CR-TH 20/25	C-150	TSC-80	R-150	
	35	CR-TH 20/35	C-150	TSC-80	R-150	
	50	CR-TH 20/50	C-200	TSC-80	R-150	
	70	CR-TH 20/70	C-200	TSC-80	R-150	
	95	CR-TH 20/95	C-200	TSC-80	R-150	
	120	CR-TH 20/120	C-250	TSC-80	R-150	
	150	CR-TH 20/150	C-250	TSC-80	R-150	
	185	CR-TH 20/185	2 x C-150	TSC-80	R-150	
240	CR-TH 20/240	2 x C-200	TSC-100	R-750	E	



80

Copper aluminothermic welding

• See mould price key on tariff.

Use sealing paste.

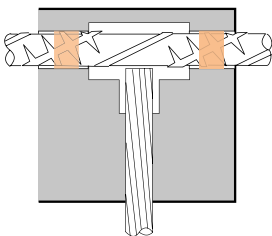

Operating instructions.

Seal the re-bar with past on both sides of the weld cavity, on the outside. Butt tap cable against the re-bar.



Connection CR-TL						
Dimension						Price key for moulds
Re-bar (mm)	Cable (mm ²)	Mould (PART. No.)	Cartridge	Clamp	Scraper	
10	25	CR-TL 10/25	C-90	TSC-80	R-90	D
	35	CR-TL 10/35	C-90	TSC-80	R-90	
	50	CR-TL 10/50	C-115	TSC-80	R-90	
	70	CR-TL 10/70	C-115	TSC-80	R-90	
	95	CR-TL 10/95	C-150	TSC-80	R-150	
	120	CR-TL 10/120	C-150	TSC-80	R-150	
	150	CR-TL 10/150	C-200	TSC-80	R-150	
16	25	CR-TL 16/25	C-150	TSC-80	R-150	
	35	CR-TL 16/35	C-150	TSC-80	R-150	
	50	CR-TL 16/50	C-150	TSC-80	R-150	
	70	CR-TL 16/70	C-150	TSC-80	R-150	
	95	CR-TL 16/95	C-200	TSC-80	R-150	
	120	CR-TL 16/120	C-200	TSC-80	R-150	
	150	CR-TL 16/150	C-250	TSC-80	R-150	
20	25	CR-TL 20/25	C-150	TSC-80	R-150	
	35	CR-TL 20/35	C-150	TSC-80	R-150	
	50	CR-TL 20/50	C-200	TSC-80	R-150	
	70	CR-TL 20/70	C-200	TSC-80	R-150	
	95	CR-TL 20/95	C-200	TSC-80	R-150	
	120	CR-TL 20/120	C-250	TSC-80	R-150	
	150	CR-TL 20/150	C-250	TSC-80	R-150	
	185	CR-TL 20/185	2 x C-150	TSC-80	R-150	
	240	CR-TL 20/240	2 x C-200	TSC-80	R-150	
						F

• See mould price key on tariff.

Use sealing paste.

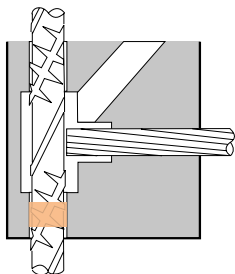

Operating instructions.

Seal the re-bar with paste below the weld cavity. Butt the tap cable against the re-bar. Use a clamp on re-bar below mould.

7. Copper aluminothermic welding /

7.4 Cable / Re-bar

Connection CR-PV

Dimension						Price key for moulds
Re-bar (mm)	Cable (mm ²)	Mould (PART. No.)	Cartridge	Clamp	Scraper	
10	25	CR-PV 10/25	C-90	TSC-80	R-90	D
	35	CR-PV 10/35	C-90	TSC-80	R-90	
	50	CR-PV 10/50	C-115	TSC-80	R-90	
	70	CR-PV 10/70	C-150	TSC-80	R-150	
	95	CR-PV 10/95	C-150	TSC-80	R-150	
16	25	CR-PV 16/25	C-115	TSC-80	R-90	
	35	CR-PV 16/35	C-115	TSC-80	R-90	
	50	CR-PV 16/50	C-150	TSC-80	R-150	
	70	CR-PV 16/70	C-150	TSC-80	R-150	
	95	CR-PV 16/95	C-200	TSC-80	R-150	
	120	CR-PV 16/120	C-200	TSC-80	R-150	
	150	CR-PV 16/150	C-200	TSC-80	R-150	
20	25	CR-PV 20/25	C-115	TSC-80	R-90	
	35	CR-PV 20/35	C-115	TSC-80	R-90	
	50	CR-PV 20/50	C-150	TSC-80	R-150	
	70	CR-PV 20/70	C-150	TSC-80	R-150	
	95	CR-PV 20/95	C-200	TSC-80	R-150	
	120	CR-PV 20/120	C-200	TSC-80	R-150	
	150	CR-PV 20/150	C-250	TSC-80	R-150	
	185	CR-PV 20/185	C-250	TSC-80	R-150	
	240	CR-PV 20/240	2 x C-150	TSC-80	R-150	



82
Copper aluminothermic welding

• See mould price key on tariff.



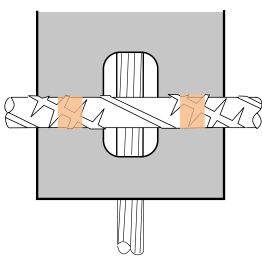

Use sealing paste.



Operating instructions.

Seal the re-bar with paste on both sides of the weld cavity, on the outside. Insert the cable in the mould secure it to the re-bar. Place the backing part and secure it to re-bar. Use a clamp on cable below mould.



Connection CR-PH						
Dimension						Price key for moulds
Re-bar (mm)	Cable (mm ²)	Mould (PART. No.)	Cartridge	Clamp	Scraper	
10	25	CR-PH 10/25	C-90	TSC-80	R-90	D
	35	CR-PH 10/35	C-90	TSC-80	R-90	
	50	CR-PH 10/50	C-115	TSC-80	R-90	
	70	CR-PH 10/70	C-115	TSC-80	R-90	
	95	CR-PH 10/95	C-150	TSC-80	R-150	
16	25	CR-PH 16/25	C-90	TSC-80	R-90	
	35	CR-PH 16/35	C-90	TSC-80	R-90	
	50	CR-PH 16/50	C-115	TSC-80	R-90	
	70	CR-PH 16/70	C-115	TSC-80	R-90	
	95	CR-PH 16/95	C-150	TSC-80	R-150	
	120	CR-PH 16/120	C-150	TSC-80	R-150	
20	150	CR-PH 16/150	C-200	TSC-80	R-150	
	25	CR-PH 20/25	C-90	TSC-80	R-90	
	35	CR-PH 20/35	C-90	TSC-80	R-90	
	50	CR-PH 20/50	C-115	TSC-80	R-90	
	70	CR-PH 20/70	C-115	TSC-80	R-90	
	95	CR-PH 20/95	C-150	TSC-80	R-150	
	120	CR-PH 20/120	C-150	TSC-80	R-150	
	150	CR-PH 20/150	C-200	TSC-80	R-150	
	185	CR-PH 20/185	C-250	TSC-80	R-150	
	240	CR-PH 20/240	2 x C-200	TSC-100	R-750	

• See mould price key on tariff.

Use sealing paste.

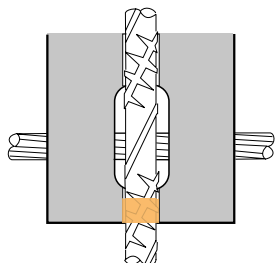

Operating instructions.

Seal the re-bar with paste below the weld cavity. Insert the cable into the mould and secure it to the re-bar. Place the backplate attachment. Use a clamp on re-bar below mould.

7. Copper aluminothermic welding /

7.4 Cable / Re-bar

Connection CR-TP

Dimension						Price key for moulds	
Re-bar (mm)	Cable (mm ²)	Mould (PART. No.)	Cartridge	Clamp	Scraper		
10	25	CR-TP 10/25	C-90	TSC-80	R-90	A	
	35	CR-TP 10/35	C-90	TSC-80	R-90		
	50	CR-TP 10/50	C-115	TSC-80	R-90		
	70	CR-TP 10/70	C-115	TSC-80	R-90		
	95	CR-TP 10/95	C-150	TSC-80	R-150		
16	25	CR-TP 16/25	C-90	TSC-80	R-90		
	35	CR-TP 16/35	C-90	TSC-80	R-90		
	50	CR-TP 16/50	C-115	TSC-80	R-90		
	70	CR-TP 16/70	C-115	TSC-80	R-90		
	95	CR-TP 16/95	C-150	TSC-80	R-150		
	120	CR-TP 16/120	C-150	TSC-80	R-150		
	150	CR-TP 16/150	C-200	TSC-80	R-150		
20	25	CR-TP 20/25	C-90	TSC-80	R-90		E
	35	CR-TP 20/35	C-90	TSC-80	R-90		
	50	CR-TP 20/50	C-115	TSC-80	R-90		
	70	CR-TP 20/70	C-115	TSC-80	R-90		
	95	CR-TP 20/95	C-150	TSC-80	R-150		
	120	CR-TP 20/120	C-150	TSC-80	R-150		
	150	CR-TP 20/150	C-200	TSC-80	R-150		
	185	CR-TP 20/185	C-250	TSC-80	R-150		
240	CR-TP 20/240	C-250	TSC-80	R-150			



• See mould price key on tariff.



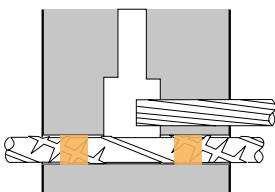

Use sealing paste.



Operating instructions.

Seal the re-bar with paste on both sides of the weld cavity, on the outside. Insert the cable up to the centre of the tap hole.

7. Copper aluminothermic welding /
 7.5 Cable / Metal plate

Connection CH-TH					
Dimension					Price key for moulds
Cable (mm ²)	Mould (PART. No.)	Cartridge	Clamp	Scraper	
25	CH-TH 25	C-65	TSC-80	R-45	A
35	CH-TH 35	C-65	TSC-80	R-45	
50	CH-TH 50	C-90	TSC-80	R-90	
70	CH-TH 70	C-90	TSC-80	R-90	
95	CH-TH 95	C-115	TSC-80	R-90	
120	CH-TH 120	C-115	TSC-80	R-90	
150	CH-TH 150	C-150	TSC-80	R-150	
185	CH-TH 185	C-200	TSC-80	R-150	
240	CH-TH 240	C-200	TSC-80	R-150	

• See mould price key on tariff.

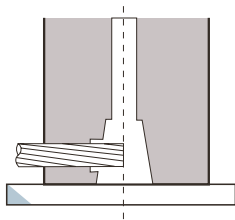

Operating instructions.

Insert the cable at the centre of the tap hole. Press on mould cover to prevent metal leaks.

7. Copper aluminothermic welding /

7.5 Cable / Metal plate

Connection CH-TF

Dimension					Price key for moulds
Cable (mm ²)	Mould (PART. No.)	Cartridge	Clamp	Scraper	
25	CH-TF 25	C-45*	TSC-80	R-45	A
35	CH-TF 35	C-45*	TSC-80	R-45	
50	CH-TF 50	C-90	TSC-80	R-90	
70	CH-TF 70	C-90	TSC-80	R-90	
95	CH-TF 95	C-115	TSC-80	R-90	
120	CH-TF 120	C-115	TSC-80	R-90	
150	CH-TF 150	C-150	TSC-80	R-150	
185	CH-TF 185	C-200	TSC-80	R-150	
240	CH-TF 240	C-200	TSC-80	R-150	

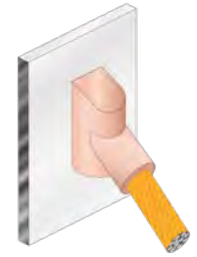



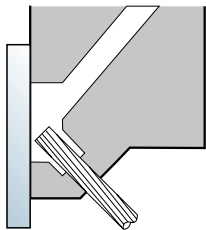

- * Possibility of using mini moulds for cartridges C-45 or smaller, with clamp TSC-50 and scraper R-M.
- See mould price key on tariff.



Operating instructions.

Insert the cable until reaching the metal plate. Secure with clamp, if possible.



Connection CH-VI					
Dimension					
Cable (mm ²)	Mould (PART. No.)	Cartridge	Clamp	Scraper	Price key for moulds
25	CH-VI 25	C-45*	TSC-80	R-45	A
35	CH-VI 35	C-65	TSC-80	R-45	
50	CH-VI 50	C-90	TSC-80	R-90	
70	CH-VI 70	C-90	TSC-80	R-90	
95	CH-VI 95	C-115	TSC-80	R-90	
120	CH-VI 120	C-115	TSC-80	R-90	
150	CH-VI 150	C-150	TSC-80	R-150	
185	CH-VI 185	C-150	TSC-80	R-150	
240	CH-VI 240	C-200	TSC-80	R-150	

- * Possibility of using mini moulds for cartridges C-45 or smaller, with clamp TSC-50 and scraper R-M.
- See mould price key on tariff.

Use sealing paste.

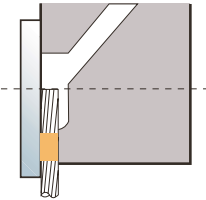





Operating instructions.

Insert the cable until the centre of the tap hole. Seal the space between the cable and the plate with mastic below the weld cavity. Secure mould to the plate with a clamp, if possible.

7. Copper aluminothermic welding /

7.5 Cable / Metal plate

Connection CH-TVD/CH-TVI

Dimension					Price key for moulds
Cable (mm ²)	Mould (PART. No.)	Cartridge	Clamp	Scraper	A
25	CH-TVD/ CH-TVI 25	C-45*	TSC-80	R-45	
35	CH-TVD/ CH-TVI 35	C-65	TSC-80	R-45	
50	CH-TVD/ CH-TVI 50	C-90	TSC-80	R-90	
70	CH-TVD/ CH-TVI 70	C-90	TSC-80	R-90	
95	CH-TVD/ CH-TVI 95	C-115	TSC-80	R-90	
120	CH-TVD/ CH-TVI 120	C-115	TSC-80	R-90	
150	CH-TVD/ CH-TVI 150	C-150	TSC-80	R-150	
185	CH-TVD/ CH-TVI 185	C-200	TSC-80	R-150	
240	CH-TVD/ CH-TVI 240	C-200	TSC-80	R-150	

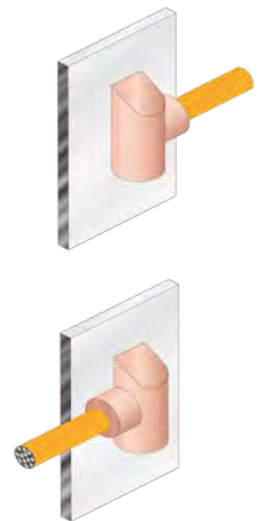

* Possibility of using mini moulds for cartridges C-45 or smaller, with clamp TSC-50 and scraper R-M.

• See mould price key on tariff.



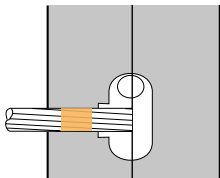

Use sealing paste.



Operating instructions.

Insert the cable up to the centre of the tap hole. Seal the space between the cable and the plate outside the weld cavity. Secure the mould to the plate with a clamp, if possible.



Connection CH-PHH					
Dimension					Price key for moulds
Cable (mm ²)	Mould (PART. No.)	Cartridge	Clamp	Scraper	A
25	CH-PHH 25	C-65	TSC-80	R-45	
35	CH-PHH 35	C-90	TSC-80	R-90	
50	CH-PHH 50	C-90	TSC-80	R-90	
70	CH-PHH 70	C-115	TSC-80	R-90	
95	CH-PHH 95	C-115	TSC-80	R-90	
120	CH-PHH 120	C-150	TSC-80	R-150	
150	CH-PHH 150	C-200	TSC-80	R-150	
185	CH-PHH 185	C-250	TSC-80	R-150	
240	CH-PHH 240	2 x C-150	TSC-80	R-150	

• See mould price key on tariff.

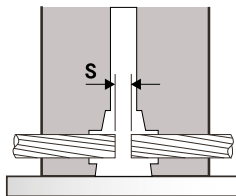





Operating instructions.

Cut and separate the cable 3 to 4 mm. Under centre of tap hole. Press on the cover of the mould to prevent metal leaks.

7. Copper aluminothermic welding /

7.5 Cable / Metal plate

Connection CH-PVH

Dimension					Price key for moulds
Cable (mm ²)	Mould (PART. No.)	Cartridge	Clamp	Scraper	
25	CH-PVH 25	C-65	TSC-80	R-45	A
35	CH-PVH 35	C-90	TSC-80	R-90	
50	CH-PVH 50	C-115	TSC-80	R-90	
70	CH-PVH 70	C-115	TSC-80	R-90	
95	CH-PVH 95	C-150	TSC-80	R-150	
120	CH-PVH 120	C-150	TSC-80	R-150	
150	CH-PVH 150	C-200	TSC-80	R-150	
185	CH-PVH 185	C-250	TSC-80	R-150	
240	CH-PVH 240	2 x C-150	TSC-80	R-150	



• See mould price key on tariff.

Use sealing paste.

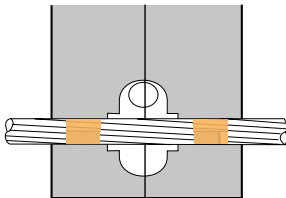





Operating instructions.

Seal the space between the cable and the plate on both sides of the weld cavity. Secure the mould to the plate with a clamp, if possible.

7. Copper aluminothermic welding / 7.5 Cable / Metal plate



Connection CH-VS					
Dimension					Price key for moulds
Cable (mm ²)	Mould (PART. No.)	Cartridge	Clamp	Scraper	
25	CH-VS 25	C-65	TSC-80	R-45	A
35	CH-VS 35	C-90	TSC-80	R-90	
50	CH-VS 50	C-115	TSC-80	R-90	
70	CH-VS 70	C-150	TSC-80	R-150	C
95	CH-VS 95	C-200	TSC-80	R-150	
120	CH-VS 120	C-200	TSC-80	R-150	
150	CH-VS 150	C-250	TSC-80	R-150	F
185	CH-VS 185	2 x C-150	TSC-80	R-150	
240	CH-VS 240	2 x C-150	TSC-80	R-150	

• See mould price key on tariff.

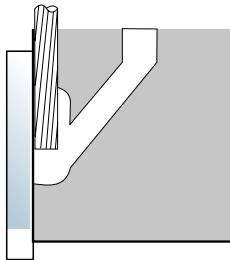





Operating instructions.

Insert the cable up to the centre of the tap hole. Secure the mould to the plate with a clamp, if possible.

7. Copper aluminothermic welding /

7.5 Cable / Metal plate

Connection CH-PVV

Dimension					Price key for moulds
Cable (mm ²)	Mould (PART. No.)	Cartridge	Clamp	Scraper	
25	CH-PVV 25	C-90	TSC-80	R-90	A
35	CH-PVV 35	C-115	TSC-80	R-90	
50	CH-PVV 50	C-150	TSC-80	R-150	C
70	CH-PVV 70	C-200	TSC-80	R-150	
95	CH-PVV 95	C-250	TSC-80	R-150	
120	CH-PVV 120	C-250	TSC-80	R-150	F
150	CH-PVV 150	2 x C-150	TSC-100	R-750	
185	CH-PVV 185	2 x C-150	TSC-100	R-750	
240	CH-PVV 240	2 x C-200	TSC-100	R-750	



• See mould price key on tariff.

Use sealing paste.

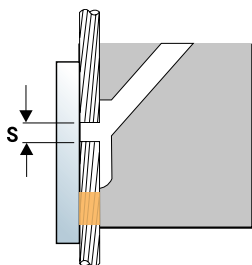

Operating instructions.

Cut and separate the cable 5 to 6 mm in the centre of the tap hole. Seal the gap between the cable and the plate with mastic below the weld cavity. Secure the mould with a clamp, if possible.

Connection CT-TH					
Dimension					Price key for moulds
Cable (mm ²)	Mould (PART. No.)	Cartridge	Clamp	Scraper	A
10	CT-TH 10	C-15	MS	R-45	
16	CT-TH 16	C-15	MS	R-45	
25	CT-TH 25	C-25	MS	R-45	
35	CT-TH 35	C-32	MS	R-45	
50	CT-TH 50	C-45	MS	R-45	
70	CT-TH 70	C-65	MS	R-45	

* See mould price key on tariff.

Use sealing paste.

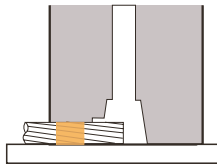

Operating instructions.

Insert the cable until the centre of the tap hole. Seal the gap between the cable and the plate with mastic outside the weld cavity. Press on the mould to prevent metal leaks.

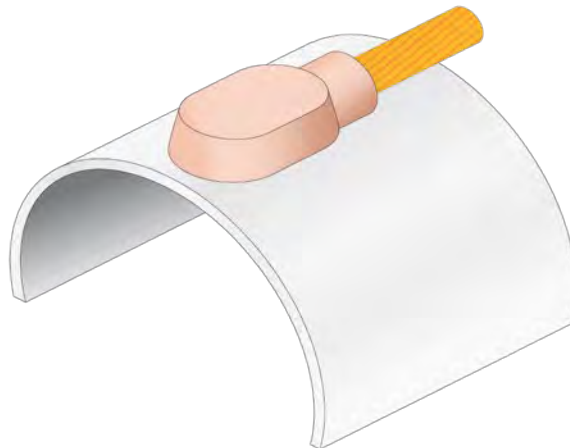

7. Copper aluminothermic welding /

7.7 Cable / Bus-bar

Connection CPL-VI (1 of 2)

Dimension						Price key for moulds
Cable (mm ²)	Bus-bar	Mould (PART. No.)	Cartridge	Clamp	Scraper	
25	20x2	CPL-VI 25/20x2	C-65	TSC-80	R-45	A
	20x3	CPL-VI 25/20x3	C-90	TSC-80	R-90	
	20x5	CPL-VI 25/20x5	C-90	TSC-80	R-90	
	25x3	CPL-VI 25/25x3	C-90	TSC-80	R-90	
	25x5	CPL-VI 25/25x5	C-115	TSC-80	R-90	
	30x3	CPL-VI 25/30x3	C-115	TSC-80	R-90	
35	20x3	CPL-VI 35/20x3	C-115	TSC-80	R-90	
	20x5	CPL-VI 35/20x5	C-115	TSC-80	R-90	
	25x3	CPL-VI 35/25x3	C-115	TSC-80	R-90	
	25x5	CPL-VI 35/25x5	C-115	TSC-80	R-90	
	30x3	CPL-VI 35/30x3	C-115	TSC-80	R-90	
	40x3	CPL-VI 35/40x3	C-115	TSC-80	R-90	
50	40x5	CPL-VI 35/40x5	C-115	TSC-80	R-90	
	20x3	CPL-VI 50/20x3	C-115	TSC-80	R-90	
	20x5	CPL-VI 50/20x5	C-115	TSC-80	R-90	
	25x3	CPL-VI 50/25x3	C-115	TSC-80	R-90	
	25x5	CPL-VI 50/25x5	C-115	TSC-80	R-90	
	30x3	CPL-VI 50/30x3	C-115	TSC-80	R-90	
	30x5	CPL-VI 50/30x5	C-115	TSC-80	R-90	
	40x3	CPL-VI 50/40x3	C-115	TSC-80	R-90	
70	40x5	CPL-VI 50/40x5	C-115	TSC-80	R-90	
	50x5	CPL-VI 50/50x5	C-115	TSC-80	R-90	
	20x3	CPL-VI 70/20x3	C-115	TSC-80	R-90	
	20x5	CPL-VI 70/20x5	C-150	TSC-80	R-150	
	25x3	CPL-VI 70/25x3	C-115	TSC-80	R-90	
	25x5	CPL-VI 70/25x5	C-150	TSC-80	R-150	
	30x3	CPL-VI 70/30x3	C-150	TSC-80	R-150	
	30x5	CPL-VI 70/30x5	C-150	TSC-80	R-150	
	40x3	CPL-VI 70/40x3	C-150	TSC-80	R-150	
40x5	CPL-VI 70/40x5	C-150	TSC-80	R-150		
50x5	CPL-VI 70/50x5	C-200	TSC-80	R-150		

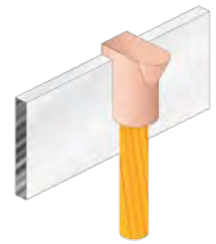

Operating instructions.
Insert end of tap cable even with upper edge of run bus-bar, seal the gap between the cable and the mould with mastic below the weld cavity.

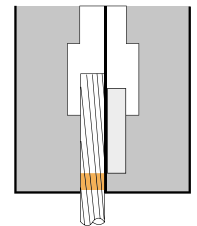

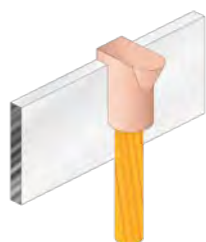
7. Copper aluminothermic welding /
 7.7 Cable / Bus-bar

Connection CPL-VI (2 of 2)						
Cable (mm ²)	Bus-bar	Mould (PART. No.)	Cartridge	Clamp	Scraper	Price key for moulds
95	20x3	CPL-VI 95/20x3	C-150	TSC-80	R-150	A
	20x5	CPL-VI 95/20x5	C-150	TSC-80	R-150	
	25x3	CPL-VI 95/25x3	C-150	TSC-80	R-150	
	25x5	CPL-VI 95/25x5	C-150	TSC-80	R-150	
	30x3	CPL-VI 95/30x3	C-200	TSC-80	R-150	
	30x5	CPL-VI 95/30x5	C-150	TSC-80	R-150	
	40x3	CPL-VI 95/40x3	C-200	TSC-80	R-150	
	40x5	CPL-VI 95/40x5	C-150	TSC-80	R-150	
	50x5	CPL-VI 95/50x5	C-250	TSC-80	R-150	
	60x5	CPL-VI 95/60x5	2 x C-150	TSC-100	R-750	D
120	20x5	CPL-VI 120/20x5	C-200	TSC-80	R-150	A
	25x3	CPL-VI 120/25x3	C-200	TSC-80	R-150	
	25x5	CPL-VI 120/25x5	C-200	TSC-80	R-150	
	30x3	CPL-VI 120/30x3	C-200	TSC-80	R-150	
	30x5	CPL-VI 120/30x5	C-200	TSC-80	R-150	
	40x3	CPL-VI 120/40x3	C-250	TSC-80	R-150	
	40x5	CPL-VI 120/40x5	C-250	TSC-80	R-150	
	50x5	CPL-VI 120/50x5	2 x C-150	TSC-100	R-750	D
150	25x5	CPL-VI 120/25x5	C-200	TSC-80	R-150	A
	30x3	CPL-VI 120/30x3	C-200	TSC-80	R-150	
	30x5	CPL-VI 120/30x5	C-200	TSC-80	R-150	
	40x3	CPL-VI 120/40x3	C-250	TSC-80	R-150	
	40x5	CPL-VI 120/40x5	C-250	TSC-80	R-150	
	50x5	CPL-VI 120/50x5	2 x C-150	TSC-100	R-750	D
185	60x5	CPL-VI 120/60x5	2 x C-150	TSC-100	R-750	A
	25x5	CPL-VI 185/25x5	C-250	TSC-80	R-150	
	30x3	CPL-VI 185/30x3	C-250	TSC-80	R-150	
	30x5	CPL-VI 185/30x5	C-250	TSC-80	R-150	
	40x3	CPL-VI 185/40x3	2 x C-150	TSC-100	R-750	
	40x5	CPL-VI 185/40x5	2 x C-150	TSC-100	R-750	
	50x5	CPL-VI 185/50x5	2 x C-150	TSC-100	R-750	
240	60x5	CPL-VI 185/60x5	2 x C-200	TSC-100	R-750	D
	25x6	CPL-VI 240/25x6	C-250	TSC-100	R-750	
	30x7	CPL-VI 240/30x7	C-250	TSC-100	R-750	
	30x9	CPL-VI 240/30x9	C-250	TSC-100	R-750	
	40x7	CPL-VI 240/40x7	2 x C-150	TSC-100	R-750	
	40x9	CPL-VI 240/40x9	2 x C-150	TSC-100	R-750	
	50x6	CPL-VI 240/50x6	2 x C-150	TSC-100	R-750	
60x6	CPL-VI 240/60x6	2 x C-200	TSC-100	R-750		

• See mould price key on tariff.

Use sealing paste.

95

Copper aluminothermic welding

 UL certificate in several
 copper welding references.





Earthing. Copper welding.



7. Copper aluminothermic welding /

7.7 Cable / Bus-bar

Connection CPL-VS

Dimension						Price key for moulds
Cable (mm ²)	Bus-bar	Mould (PART. No.)	Cartridge	Clamp	Scraper	
25	2	CPL-VS 25/...x2	C-45	TSC-80	R-45	D
	3	CPL-VS 25/...x3	C-65	TSC-80	R-45	
	4	CPL-VS 25/...x4	C-65	TSC-80	R-45	
	5	CPL-VS 25/...x5	C-90	TSC-80	R-90	
35	2	CPL-VS 35/...x2	C-65	TSC-80	R-45	
	3	CPL-VS 35/...x3	C-90	TSC-80	R-90	
	4	CPL-VS 35/...x4	C-90	TSC-80	R-90	
	5	CPL-VS 35/...x5	C-90	TSC-80	R-90	
50	2	CPL-VS 50/...x2	C-90	TSC-80	R-90	
	3	CPL-VS 50/...x3	C-115	TSC-80	R-90	
	4	CPL-VS 50/...x4	C-115	TSC-80	R-90	
	5	CPL-VS 50/...x5	C-115	TSC-80	R-90	
70	2	CPL-VS 70/...x2	C-115	TSC-80	R-90	
	3	CPL-VS 70/...x3	C-115	TSC-80	R-90	
	4	CPL-VS 70/...x4	C-115	TSC-80	R-90	
	5	CPL-VS 70/...x5	C-115	TSC-80	R-90	
95	2	CPL-VS 95/...x2	C-115	TSC-80	R-90	
	3	CPL-VS 95/...x3	C-150	TSC-80	R-150	
	4	CPL-VS 95/...x4	C-150	TSC-80	R-150	
	5	CPL-VS 95/...x5	C-150	TSC-80	R-150	
120	2	CPL-VS 120/...x2	C-200	TSC-80	R-150	
	3	CPL-VS 120/...x3	C-200	TSC-80	R-150	
	4	CPL-VS 120/...x4	C-200	TSC-80	R-150	
	5	CPL-VS 120/...x5	C-200	TSC-80	R-150	
150	2	CPL-VS 150/...x2	C-200	TSC-80	R-150	
	3	CPL-VS 150/...x3	C-200	TSC-80	R-150	
	4	CPL-VS 150/...x4	C-200	TSC-80	R-150	
	5	CPL-VS 150/...x5	C-200	TSC-80	R-150	
185	2	CPL-VS 185/...x2	C-200	TSC-80	R-150	
	3	CPL-VS 185/...x3	C-200	TSC-80	R-150	
	4	CPL-VS 185/...x4	C-200	TSC-80	R-150	
	5	CPL-VS 185/...x5	C-250	TSC-80	R-150	
240	2	CPL-VS 240/...x2	C-250	TSC-80	R-150	
	3	CPL-VS 240/...x3	C-250	TSC-80	R-150	
	4	CPL-VS 240/...x4	C-250	TSC-80	R-150	
	5	CPL-VS 240/...x5	2 x C-150	TSC-80	R-750	

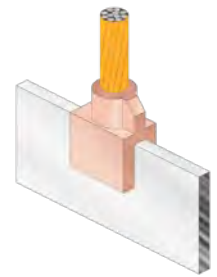

Operating instructions.
Run bus-bar is inserted to seat in mould. Butt tap cable against upper edge of run bus-bar.

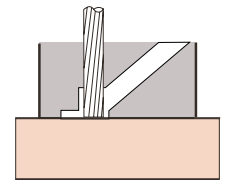

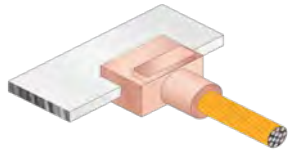

• See mould price key on tariff.

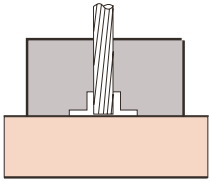

Operating instructions.
 Run bus-bar is inserted to seat in mould. Butt tap cable against upper edge of run bus-bar.



Connection CPL-H						
Dimension						Price key for moulds
Cable (mm ²)	Bus-bar	Mould (PART. No.)	Cartridge	Clamp	Scraper	
25	2	CPL-H 25/...x2	C-45*	TSC-80	R-45	A
	3	CPL-H 25/...x3	C-65	TSC-80	R-45	
	4	CPL-H 25/...x4	C-65	TSC-80	R-45	
	5	CPL-H 25/...x5	C-65	TSC-80	R-45	
35	2	CPL-H 35/...x2	C-45*	TSC-80	R-45	
	3	CPL-H 35/...x3	C-65	TSC-80	R-45	
	4	CPL-H 35/...x5	C-65	TSC-80	R-45	
	5	CPL-H 35/...x3	C-65	TSC-80	R-45	
50	2	CPL-H 50/...x2	C-45*	TSC-80	R-45	
	3	CPL-H 50/...x3	C-65	TSC-80	R-45	
	4	CPL-H 50/...x5	C-65	TSC-80	R-45	
	5	CPL-H 50/...x3	C-65	TSC-80	R-45	
70	2	CPL-H 70/...x2	C-45*	TSC-80	R-45	
	3	CPL-H 70/...x3	C-90	TSC-80	R-90	
	4	CPL-H 70/...x4	C-90	TSC-80	R-90	
	5	CPL-H 70/...x5	C-90	TSC-80	R-90	
95	2	CPL-H 95/...x2	C-65	TSC-80	R-45	
	3	CPL-H 95/...x3	C-90	TSC-80	R-90	
	4	CPL-H 95/...x4	C-90	TSC-80	R-90	
	5	CPL-H 95/...x5	C-115	TSC-80	R-90	
120	2	CPL-H 120/...x2	C-115	TSC-80	R-90	
	3	CPL-H 120/...x3	C-115	TSC-80	R-90	
	4	CPL-H 120/...x4	C-115	TSC-80	R-90	
	5	CPL-H 120/...x5	C-115	TSC-80	R-90	
150	2	CPL-H 150/...x2	C-115	TSC-80	R-90	
	3	CPL-H 150/...x3	C-115	TSC-80	R-90	
	4	CPL-H 150/...x4	C-115	TSC-80	R-90	
	5	CPL-H 150/...x5	C-115	TSC-80	R-90	
185	2	CPL-H 185/...x2	C-115	TSC-80	R-90	
	3	CPL-H 185/...x3	C-150	TSC-80	R-150	
	4	CPL-H 185/...x4	C-150	TSC-80	R-150	
	5	CPL-H 185/...x5	C-150	TSC-80	R-150	
240	2	CPL-H 240/...x2	C-150	TSC-80	R-150	
	3	CPL-H 240/...x3	C-150	TSC-80	R-150	
	4	CPL-H 240/...x4	C-150	TSC-80	R-150	
	5	CPL-H 240/...x5	C-200	TSC-80	R-150	

* Possibility of using mini moulds for cartridges C-45 or smaller, with clamp TSC-50 and scraper R-M.
 • See mould price key on tariff.

7. Copper aluminothermic welding /

7.7 Cable / Bus-bar

Connection CPL-T (1 of 2)

Dimension						Price key for moulds
Cable (mm ²)	Bus-bar	Mould (PART. No.)	Cartridge	Clamp	Scraper	
25	20x2	CPL-T 25/20x2	C-45*	TSC-80	R-45	A
	20x3	CPL-T 25/20x3	C-45*	TSC-80	R-45	
	20x5	CPL-T 25/20x5	C-45*	TSC-80	R-45	
	25x3	CPL-T 25/25x3	C-45*	TSC-80	R-45	
35	20x2	CPL-T 35/20x2	C-45*	TSC-80	R-45	
	20x3	CPL-T 35/20x3	C-45*	TSC-80	R-45	
	20x5	CPL-T 35/20x5	C-65	TSC-80	R-45	
	25x3	CPL-T 35/25x3	C-65	TSC-80	R-45	
50	20x2	CPL-T 50/20x2	C-45	TSC-80	R-45	
	20x3	CPL-T 50/20x3	C-65	TSC-80	R-45	
	20x5	CPL-T 50/20x5	C-65	TSC-80	R-45	
	25x3	CPL-T 50/25x3	C-90	TSC-80	R-90	
	25x5	CPL-T 50/25x5	C-90	TSC-80	R-90	
70	20x2	CPL-T 70/20x2	C-65	TSC-80	R-90	
	20x3	CPL-T 70/20x3	C-90	TSC-80	R-90	
	20x5	CPL-T 70/20x5	C-90	TSC-80	R-90	
	25x3	CPL-T 70/25x3	C-90	TSC-80	R-90	
	25x5	CPL-T 70/25x5	C-115	TSC-80	R-90	
	30x3	CPL-T 70/30x3	C-115	TSC-80	R-90	
95	20x3	CPL-T 95/20x3	C-115	TSC-80	R-90	
	20x5	CPL-T 95/20x5	C-150	TSC-80	R-150	
	25x3	CPL-T 95/25x3	C-150	TSC-80	R-150	
	25x5	CPL-T 95/25x5	C-150	TSC-80	R-150	
	30x3	CPL-T 95/30x3	C-150	TSC-80	R-150	
	30x5	CPL-T 95/30x5	C-150	TSC-80	R-150	
	40x3	CPL-T 95/40x3	C-150	TSC-80	R-150	
	40x5	CPL-T 95/40x5	C-150	TSC-80	R-150	
	50x5	CPL-T 95/50x5	C-200	TSC-80	R-150	

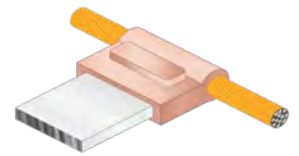

Operating instructions.
Butt tap bus-bar against side of run cable.

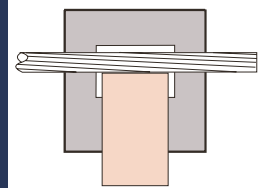

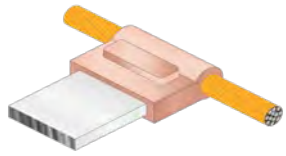
7. Copper aluminothermic welding /
 7.7 Cable / Bus-bar





Connection CPL-T (2 of 2)						
Cable (mm ²)	Bus-bar	Mould (PART. No.)	Cartridge	Clamp	Scraper	Price key for moulds
120	20x3	CPL-T 120/20x3	C-150	TSC-80	R-150	A
	20x5	CPL-T 120/20x5	C-150	TSC-80	R-150	
	25x3	CPL-T 120/25x3	C-150	TSC-80	R-150	
	25x5	CPL-T 120/25x5	C-150	TSC-80	R-150	
	30x3	CPL-T 120/30x3	C-200	TSC-80	R-150	
	30x5	CPL-T 120/30x5	C-200	TSC-80	R-150	
	40x3	CPL-T 120/40x3	C-200	TSC-80	R-150	
	40x5	CPL-T120/40x5	C-200	TSC-80	R-150	
	50x5	CPL-T 120/50x5	C-250	TSC-80	R-150	
	60x5	CPL-T 120/60x5	2 x C-150	TSC-100	R-750	F
150	20x5	CPL-T 150/20x5	C-200	TSC-80	R-150	A
	25x3	CPL-T 150/25x3	C-200	TSC-80	R-150	
	25x5	CPL-T 150/25x5	C-200	TSC-80	R-150	
	30x3	CPL-T 150/30x3	C-200	TSC-80	R-150	
	30x5	CPL-T 150/30x5	C-200	TSC-80	R-150	
	40x3	CPL-T 150/40x3	C-250	TSC-80	R-150	
	40x5	CPL-T150/40x5	C-250	TSC-80	R-150	
	50x5	CPL-T 150/50x5	2 x C-150	TSC-80	R-150	
	60x5	CPL-T 150/60x5	2 x C-150	TSC-100	R-750	F
185	25x5	CPL-T 185/25x5	C-200	TSC-80	R-150	A
	30x3	CPL-T 185/30x3	C-200	TSC-80	R-150	
	30x5	CPL-T 185/30x5	C-200	TSC-80	R-150	
	40x3	CPL-T 185/40x3	C-250	TSC-80	R-150	
	40x5	CPL-T185/40x5	C-250	TSC-80	R-150	
	50x5	CPL-T 185/50x5	2 x C-150	TSC-80	R-150	
	60x5	CPL-T 185/60x5	2 x C-150	TSC-100	R-750	F
240	25x5	CPL-T 240/25x5	C-250	TSC-80	R-150	A
	30x3	CPL-T 240/30x3	C-250	TSC-80	R-150	
	30x5	CPL-T 240/30x5	C-250	TSC-80	R-150	
	40x3	CPL-T 240/40x3	2 x C-150	TSC-80	R-150	
	40x5	CPL-T 240/40x5	2 x C-150	TSC-80	R-150	
	50x5	CPL-T 240/50x5	2 x C-200	TSC-100	R-750	
	60x5	CPL-T 240/60x5	2 x C-200	TSC-100	R-750	

- * Possibility of using mini moulds for cartridges C-45 or smaller, with clamp TSC-50 and scraper R-M.
- See mould price key on tariff.

7. Copper aluminothermic welding /

7.7 Cable / Bus-bar

Connection CPL-L (1 of 2)

Dimension					
Cable (mm ²)	Bus-bar	Mould (PART. No.)	Cartridge	Clamp	Scraper
25	20x2	CPL-L 25/20x2	C-32*	TSC-80	R-45
	20x3	CPL-L 25/20x3	C-45*	TSC-80	R-45
35	20x2	CPL-L 35/20x2	C-45*	TSC-80	R-45
	20x3	CPL-L 35/20x3	C-45*	TSC-80	R-45
	20x5	CPL-L 35/20x5	C-65	TSC-80	R-45
50	25x3	CPL-L 35/25x3	C-45*	TSC-80	R-45
	20x2	CPL-L 50/20x2	C-45*	TSC-80	R-45
	20x3	CPL-L 50/20x3	C-45	TSC-80	R-45
	20x5	CPL-L 50/20x5	C-65	TSC-80	R-45
70	25x3	CPL-L 50/25x3	C-65	TSC-80	R-45
	20x2	CPL-L 70/20x2	C-45*	TSC-80	R-45
	20x3	CPL-L 70/20x3	C-65	TSC-80	R-45
	20x5	CPL-L 70/20x5	C-65	TSC-80	R-90
	25x5	CPL-L 70/25x5	C-90	TSC-80	R-90
95	20x2	CPL-L 95/20x2	C-65	TSC-80	R-90
	20x3	CPL-L 95/20x3	C-90	TSC-80	R-90
	20x5	CPL-L 95/20x5	C-90	TSC-80	R-90
	25x3	CPL-L 95/25x3	C-90	TSC-80	R-90
	25x5	CPL-L 95/25x5	C-115	TSC-80	R-90
	30x3	CPL-L 95/30x3	C-90	TSC-80	R-90
120	20x3	CPL-L 120/20x3	C-115	TSC-80	R-90
	20x5	CPL-L 120/20x5	C-115	TSC-80	R-90
	25x3	CPL-L 120/25x3	C-115	TSC-80	R-90
	25x5	CPL-L 120/25x5	C-115	TSC-80	R-90
	30x3	CPL-L 120/30x3	C-115	TSC-80	R-90
	30x5	CPL-L 120/30x5	C-115	TSC-80	R-90
	40x3	CPL-L 120/40x3	C-115	TSC-80	R-90
	40x5	CPL-L 120/40x5	C-150	TSC-80	R-150

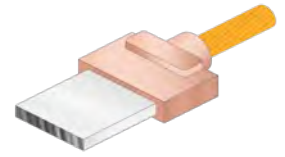

Operating instructions.
Butt ends of cable and bus-bar under centre of tap hole.

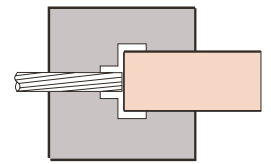

B

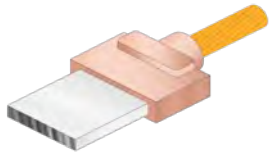
7. Copper aluminothermic welding /
 7.7 Cable / Bus-bar

Connection CPL-L (2 of 2)						
Cable (mm ²)	Bus-bar	Mould (PART. No.)	Cartridge	Clamp	Scraper	Price key for moulds
150	20x3	CPL-L 150/20x3	C-115	TSC-80	R-90	B
	20x5	CPL-L 150/20x5	C-115	TSC-80	R-90	
	25x3	CPL-L 150/25x3	C-115	TSC-80	R-90	
	25x5	CPL-L 150/25x5	C-115	TSC-80	R-90	
	30x3	CPL-L 150/30x3	C-115	TSC-80	R-90	
	30x5	CPL-L 150/30x5	C-115	TSC-80	R-90	
	40x3	CPL-L 150/40x3	C-115	TSC-80	R-90	
	40x5	CPL-L 150/40x5	C-115	TSC-80	R-90	
185	50x5	CPL-L 150/50x5	C-150	TSC-80	R-150	
	20x3	CPL-L 185/20x3	C-115	TSC-80	R-90	
	20x5	CPL-L 185/20x5	C-150	TSC-80	R-150	
	25x3	CPL-L 185/25x3	C-150	TSC-80	R-150	
	25x5	CPL-L 185/25x5	C-150	TSC-80	R-150	
	30x3	CPL-L 185/30x3	C-150	TSC-80	R-150	
	30x5	CPL-L 185/30x5	C-150	TSC-80	R-150	
	40x3	CPL-L 185/40x3	C-150	TSC-80	R-150	
240	40x5	CPL-L 185/40x5	C-150	TSC-80	R-150	
	50x5	CPL-L 185/50x5	C-200	TSC-80	R-150	
	20x3	CPL-L 240/20x3	C-150	TSC-80	R-150	
	20x5	CPL-L 240/20x5	C-150	TSC-80	R-150	
	25x3	CPL-L 240/25x3	C-150	TSC-80	R-150	
	25x5	CPL-L 240/25x5	C-150	TSC-80	R-150	
	30x3	CPL-L 240/30x3	C-200	TSC-80	R-150	
	30x5	CPL-L 240/30x5	C-200	TSC-80	R-150	
	40x3	CPL-L 240/40x3	C-200	TSC-80	R-150	
	40x5	CPL-L 240/40x5	C-200	TSC-80	R-150	
	50x5	CPL-L 240/50x5	C-250	TSC-80	R-150	
	60x5	CPL-L 240/60x5	2 x C-150	TSC-100	R-750	F

- * Possibility of using mini moulds for cartridges C-45 or smaller, with clamp TSC-50 and scraper R-M.
- See mould price key on tariff.

7. Copper aluminothermic welding /

7.8 Bus-bar / Bus-bar

Connection PL-LV

Dimension					Price key for moulds
Bus-bar	Mould (PART. No.)	Cartridge	Clamp	Scraper	
20x2	PL-LV 20x2	C-45*	TSC-80	R-45	A
20x3	PL-LV 20x3	C-45*	TSC-80	R-45	
20x5	PL-LV 20x5	C-65	TSC-80	R-45	
25x3	PL-LV 25x3	C-65	TSC-80	R-45	
25x5	PL-LV 25x5	C-90	TSC-80	R-90	
30x3	PL-LV 30x3	C-90	TSC-80	R-90	
30x5	PL-LV 30x5	C-115	TSC-80	R-90	
40x3	PL-LV 40x3	C-115	TSC-80	R-90	B
40x5	PL-LV 40x5	C-150	TSC-80	R-150	
50x5	PL-LV 50x5	C-200	TSC-80	R-150	E
60x5	PL-LV 60x5	2 x C-150	TSC-100	R-750	

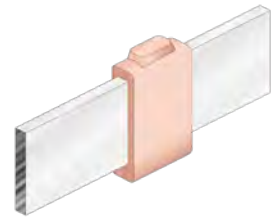

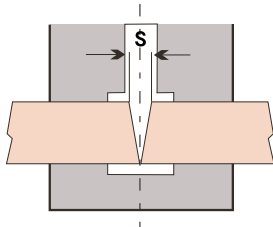

- * Possibility of using mini moulds for cartridges C-45 or smaller, with clamp TSC-50 and scraper R-M.
- See mould price key on tariff.

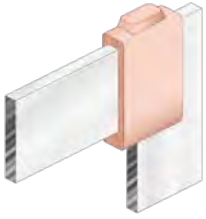

Operating instructions.

End of bus-bar less than 30 mm wide must be cut in "V" under centre tap holes (S) 5 to 6 mm. Busbar wider than 30 mm (S) 10 to 12 mm.



Connection PL-ARI					
Dimension					Price key for moulds
Bus-bar	Mould (PART. No.)	Cartridge	Clamp	Scraper	
20x2	PL-ARI 20x2	C-45*	TSC-80	R-45	A
20x3	PL-ARI 20x3	C-45*	TSC-80	R-45	
20x5	PL-ARI 20x5	C-65	TSC-80	R-45	
25x3	PL-ARI 25x3	C-65	TSC-80	R-45	
25x5	PL-ARI 25x5	C-90	TSC-80	R-90	
30x3	PL-ARI 30x3	C-90	TSC-80	R-90	
30x5	PL-ARI 30x5	C-115	TSC-80	R-90	
40x3	PL-ARI 40x3	C-115	TSC-80	R-90	B
40x5	PL-ARI 40x5	C-150	TSC-80	R-150	
50x5	PL-ARI 50x5	C-200	TSC-80	R-150	E
60x5	PL-ARI 60x5	2 x C-150	TSC-100	R-750	

- * Possibility of using mini moulds for cartridges C-45 or smaller, with clamp TSC-50 and scraper R-M.
- See mould price key on tariff.

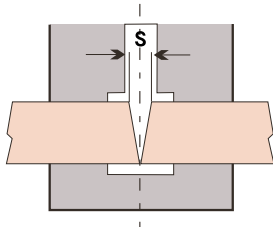

Operating instructions.

End of bus-bar less than 30 mm wide must be cut in "V" under centre tap holes (S) 5 to 6 mm. Busbar wider than 30 mm (S) 10 to 12 mm.

7. Copper aluminothermic welding /

7.8 Bus-bar / Bus-bar

Connection PL-TV

Dimension					
Bus-bar	Mould (PART. No.)	Cartridge	Clamp	Scraper	Price key for moulds
20x2	PL-TV 20x2	C-45*	TSC-80	R-45	A
20x3	PL-TV 20x3	C-65	TSC-80	R-45	
20x5	PL-TV 20x5	C-65	TSC-80	R-45	
25x3	PL-TV 25x3	C-90	TSC-80	R-90	
25x5	PL-TV 25x5	C-90	TSC-80	R-90	
30x3	PL-TV 30x3	C-90	TSC-80	R-90	
30x5	PL-TV 30x5	C-115	TSC-80	R-90	
40x3	PL-TV 40x3	C-115	TSC-80	R-90	B
40x5	PL-TV 40x5	C-150	TSC-80	R-150	
50x5	PL-TV 50x5	C-200	TSC-80	R-150	E
60x5	PL-TV 60x5	2 x C-150	TSC-100	R-750	

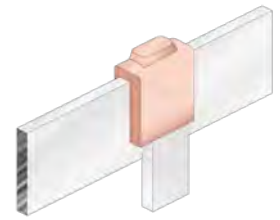

* Possibility of using mini moulds for cartridges C-45 or smaller, with clamp TSC-50 and scraper R-M.

• See mould price key on tariff.

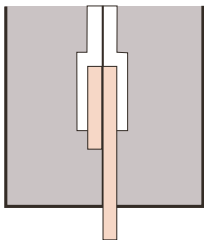

Operating instructions.

Insert the end of tap bus-bar even with upper edge of run bus-bar.

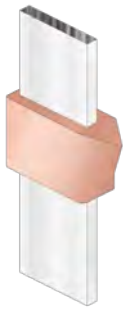
7. Copper aluminothermic welding /
 7.8 Bus-bar / Bus-bar

Connection PL-V					
Dimension					Price key for moulds
Bus-bar	Mould (PART. No.)	Cartridge	Clamp	Scraper	
20x2	PL-V 20x2	C-65	TSC-80	R-45	B
20x3	PL-V 20x3	C-65	TSC-80	R-45	
20x5	PL-V 20x5	C-90	TSC-80	R-90	D
25x3	PL-V 25x3	C-90	TSC-80	R-90	
25x5	PL-V 25x5	C-115	TSC-80	R-90	
30x3	PL-V 30x3	C-115	TSC-80	R-90	H
30x5	PL-V 30x5	C-150	TSC-80	R-150	
40x3	PL-V 40x3	C-150	TSC-80	R-150	
40x5	PL-V 40x5	C-200	TSC-80	R-150	J
50x5	PL-V 50x5	C-250	TSC-80	R-150	
60x5	PL-V 60x5	2 x C-150	TSC-100	R-750	

• See mould price key on tariff.

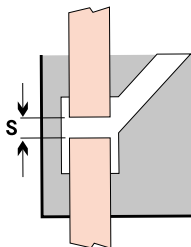
Operating instructions.

The ends of bus-bars of up to 6 mm thick must be separated (S) 5-6 mm. in the centre of the tap hole. Bus-bar thicker than 6 mm (S) 10-12 mm.

7. Copper aluminothermic welding /

7.8 Bus-bar / Bus-bar

Connection PL-TS

Dimension					Price key for moulds
Bus-bar	Mould (PART. No.)	Cartridge	Clamp	Scraper	
20x2	PL-TS 20x2	C-115	TSC-80	R-90	D
20x3	PL-TS 20x3	C-115	TSC-80	R-90	
20x5	PL-TS 20x5	C-150	TSC-80	R-150	
25x3	PL-TS 25x3	C-150	TSC-80	R-150	
25x5	PL-TS 25x5	C-200	TSC-80	R-150	
30x3	PL-TS 30x3	C-200	TSC-80	R-150	
30x5	PL-TS 30x5	C-250	TSC-80	R-150	
40x3	PL-TS 40x3	C-250	TSC-80	R-150	
40x5	PL-TS 40x5	2 x C-150	TSC-100	R-750	I
50x5	PL-TS 50x5	2 x C-200	TSC-100	R-750	
60x5	PL-TS 60x5	2 x C-250	TSC-100	R-750	

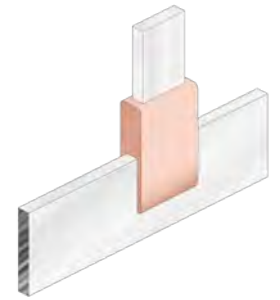

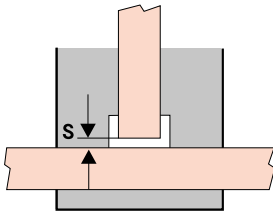

• See mould price key on tariff.

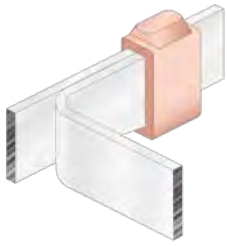

Operating instructions.

Leave a gap of (S) 5-6 mm between the tap bus-bar and the run bus-bar. Secure them with backing plate attachment.



Connection PL-DP					
Dimension					Price key for moulds
Bus-bar	Mould (PART. No.)	Cartridge	Clamp	Scraper	
20x2	PL-DP 20x2	C-90	TSC-80	R-90	B
20x3	PL-DP 20x3	C-90	TSC-80	R-90	
20x5	PL-DP 20x5	C-90	TSC-80	R-90	C
25x3	PL-DP 25x3	C-90	TSC-80	R-90	
25x5	PL-DP 25x5	C-90	TSC-80	R-90	
30x3	PL-DP 30x3	C-115	TSC-80	R-90	
30x5	PL-DP 30x5	C-115	TSC-80	R-90	
40x3	PL-DP 40x3	C-115	TSC-80	R-90	
40x5	PL-DP 40x5	C-200	TSC-80	R-150	
50x5	PL-DP 50x5	C-200	TSC-80	R-150	I
60x5	PL-DP 60x5	2 x C-200	TSC-100	R-750	

• See mould price key on tariff.

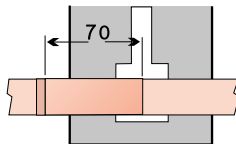

Operating instructions.

Insert end of tap bus-bar up to the centre of the tap hole. Tab bus-bar must be at least 70 mm parallel to the run bus-bar.

7. Copper aluminothermic welding /

7.8 Bus-bar / Bus-bar

Connection PL-LH

Dimension					Price key for moulds
Bus-bar	Mould (PART. No.)	Cartridge	Clamp	Scraper	
20x2	PL-LH 20x2	C-45*	TSC-80	R-45	B
20x3	PL-LH 20x3	C-45*	TSC-80	R-45	
20x5	PL-LH 20x5	C-65	TSC-80	R-45	
25x3	PL-LH 25x3	C-65	TSC-80	R-45	
25x5	PL-LH 25x5	C-90	TSC-80	R-90	
30x3	PL-LH 30x3	C-90	TSC-80	R-90	
30x5	PL-LH 30x5	C-115	TSC-80	R-90	
40x3	PL-LH 40x3	C-150	TSC-80	R-150	
40x5	PL-LH 40x5	C-150	TSC-80	R-150	
50x5	PL-LH 50x5	C-200	TSC-80	R-150	
60x5	PL-LH 60x5	2 x C-150	TSC-100	R-750	F

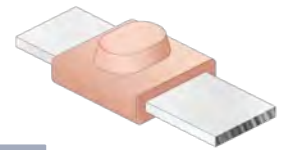



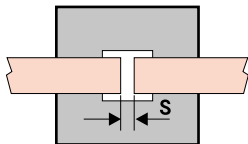

- * Possibility of using mini moulds for cartridges C-45 or smaller, with clamp TSC-50 and scraper R-M.
- See mould price key on tariff.

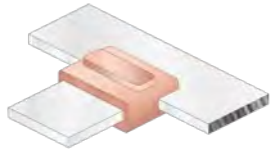

Operating instructions.

Bus-bar up to 3 mm thick must be separated (S) 3 mm in the centre of the tap hole. Bus-bars thicker than 3 mm must be separated (S) 5-6 mm.



Connection PL-TH					
Dimension					Price key for moulds
Bus-bar	Mould (PART. No.)	Cartridge	Clamp	Scraper	
20x2	PL-TH 20x2	C-45*	TSC-80	R-45	B
20x3	PL-TH 20x3	C-45*	TSC-80	R-45	
20x5	PL-TH 20x5	C-65	TSC-80	R-45	
25x3	PL-TH 25x3	C-65	TSC-80	R-45	
25x5	PL-TH 25x5	C-90	TSC-80	R-90	
30x3	PL-TH 30x3	C-90	TSC-80	R-90	
30x5	PL-TH 30x5	C-115	TSC-80	R-90	
40x3	PL-TH 40x3	C-150	TSC-80	R-150	
40x5	PL-TH 40x5	C-150	TSC-80	R-150	
50x5	PL-TH 50x5	C-200	TSC-80	R-150	
60x5	PL-TH 60x5	2 x C-150	TSC-100	R-750	F

- * Possibility of using mini moulds for cartridges C-45 or smaller, with clamp TSC-50 and scraper R-M.
- See mould price key on tariff.

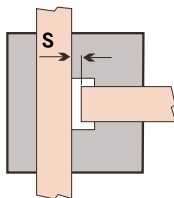

Operating instructions.

Tap bus-bars of up to 6 mm thick must be separated (S) 5-6 mm from the run bus bar. Busbar thicker than 6 mm must be separated (S)10 mm.

7. Copper aluminothermic welding /

7.8 Bus-bar / Bus-bar

Connection PL-X

Dimension					Price key for moulds
Bus-bar	Mould (PART. No.)	Cartridge	Clamp	Scraper	
20x2	PL-X 20x2	C-45*	TSC-80	R-45	B
20x3	PL-X 20x3	C-65	TSC-80	R-45	
20x5	PL-X 20x5	C-65	TSC-80	R-45	
25x3	PL-X 25x3	C-65	TSC-80	R-45	
25x5	PL-X 25x5	C-90	TSC-80	R-90	
30x3	PL-X 30x3	C-90	TSC-80	R-90	
30x5	PL-X 30x5	C-115	TSC-80	R-90	
40x3	PL-X 40x3	C-115	TSC-80	R-90	
40x5	PL-X 40x5	C-150	TSC-80	R-150	
50x5	PL-X 50x5	C-200	TSC-80	R-150	
60x5	PL-X 60x5	C-250	TSC-80	R-150	

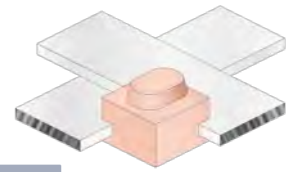

Operating instructions.
Place bus-bar in the mould slots.

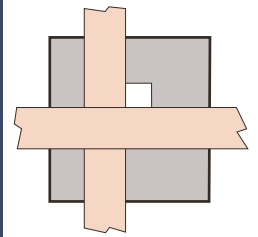

For other types of welding consult.

Moulds 1 connection

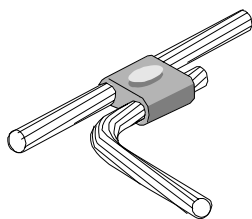
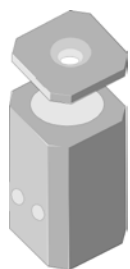

Connection type	Conductor range (mm ²)		
	From	to	
CC-D 35A	35/35		In boxes of 12 moulds
CP-T 35A	142/35	146/35	In boxes of 12 moulds

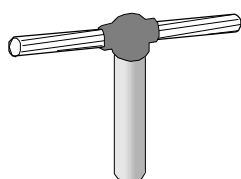
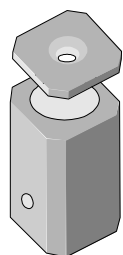

- * Possibility of using mini moulds for cartridges C-45 or smaller, with clamp TSC-50 and scraper R-M.
- See mould price key on tariff.

Ignition procedure LsVIP

Ignition procedure for aluminothermic welding charges for electrical connections

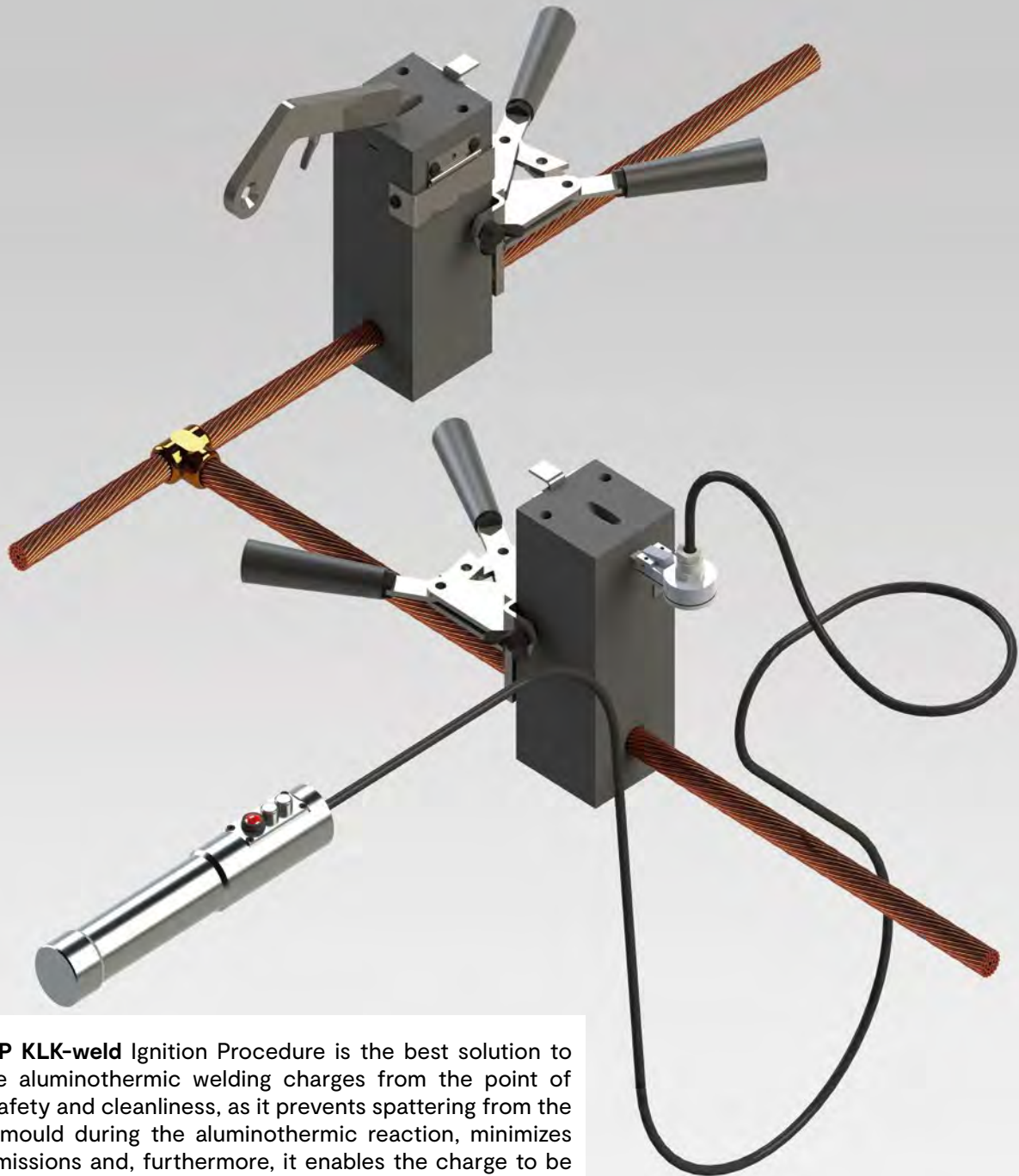

The **LsVIP KLK-weld** Ignition Procedure is the best solution to ignite the aluminothermic welding charges from the point of view of safety and cleanliness, as it prevents spattering from the crucible-mould during the aluminothermic reaction, minimizes smoke emissions and, furthermore, it enables the charge to be ignited at a certain distance from the mould, using the **KLK-weld Remote Ignition Device**.

7. Copper aluminothermic welding / 7.9 LsVIP



The **LsVIP KLK-weld Ignition Procedure** uses a special lid that completely closes the mould crucible, so that it prevents spattering from the aluminothermic reaction. But at the same time it allows the release of overpressures within the crucible. Furthermore, the smoke emissions are much lower than in other ignition procedures.

The special lid used in the Ignition Procedure can be used either with the standard flint igniter or with the **KLK-weld Remote Ignition Device**. The same applies to the cartridges, ignition powder, and the other welding accessories, thus there is a complete versatility to use either of the two ignition options.

Apart from the supplying of moulds with the special lid used in the procedure (the LsVIP moulds) a quick fastening special lid can also be supplied, this can be easily fitted onto a mould that uses the usual lid. In this case, to use the special lid, it is sufficient to leave the usual lid open.





The **KLK-weld Remote Ignition Device** includes sufficient cable to allow the charge to be ignited at a certain distance from the mould where the reaction takes place. It only requires two standard batteries and it includes warning lights that indicate when the batteries are dead or if the fuse is properly inserted into the clamp.

For each ignition using the **KLK-weld Remote Ignition Device** it is also necessary to use a fuse, one end of which is inserted into the device clamp, the other end into the lid seat made for this purpose. The fuses are the only additional consumables for the remote ignition procedure.

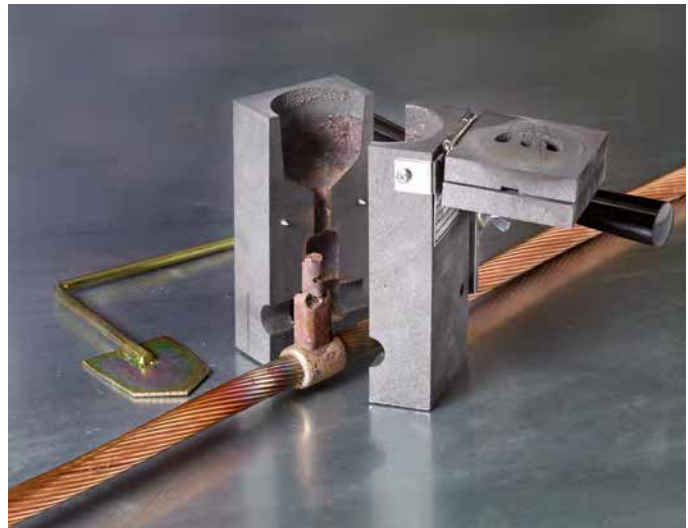

The connections achieved using the **KLK-weld** welding procedures, and in particular those achieved after using the **LsVIP Ignition Procedure**, are connections with a very high electrical conductivity, equal or greater to that of the welded conductor.



Easy and quick to use

114

Copper aluminothermic welding

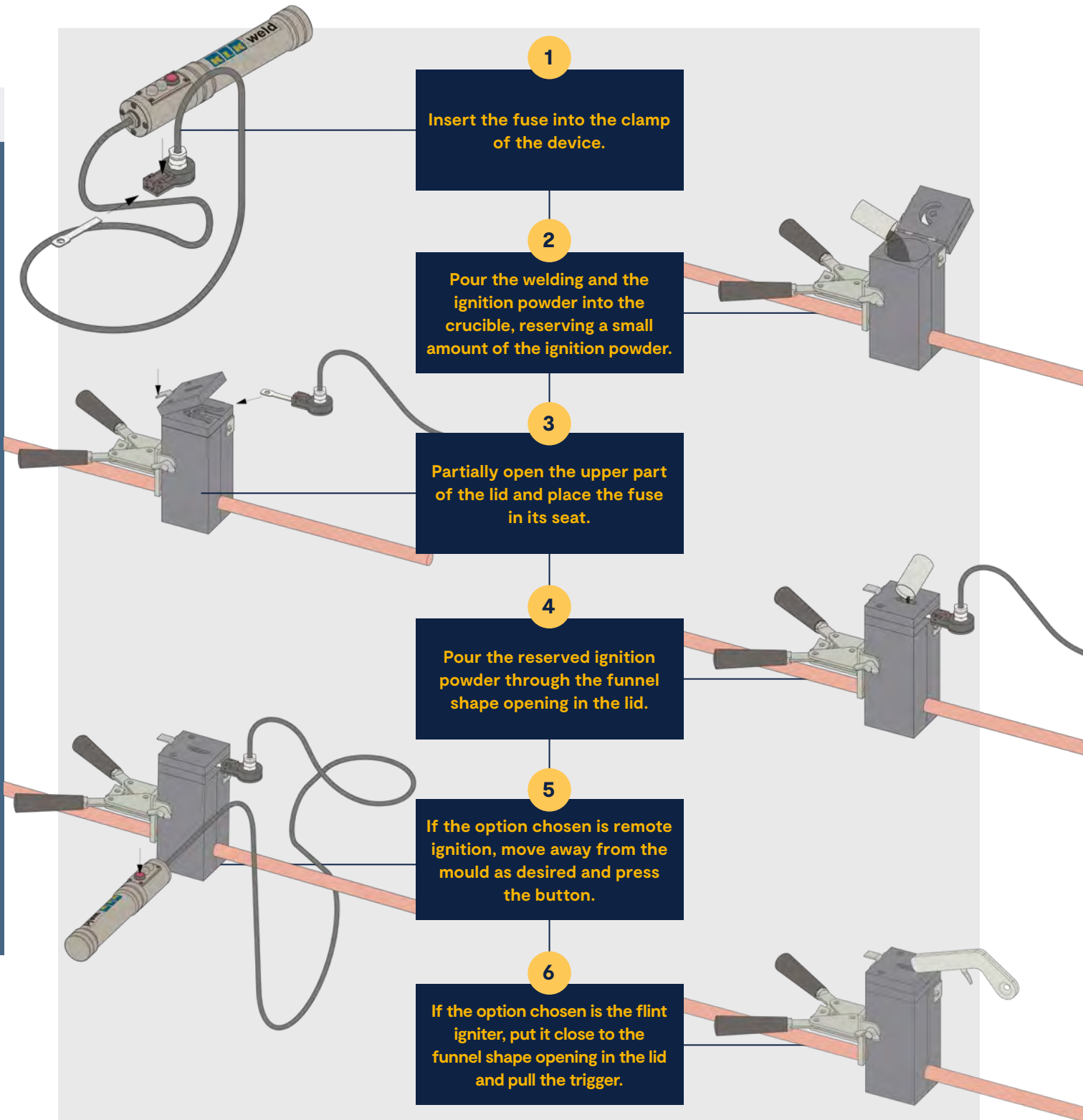

Advantages of the LsVIP process

1. **KLK remote welding (LsVIP)** is done with the same cartridges and it is not necessary to have other references of special cartridges. Our cartridges preserve the two separate powders but together in the same packaging, to prevent the user from forgetting the ignition powder.
2. The same molds that are used in all other welds can be used, only the cover is changed, because our molds have interchangeable covers. Remote welding, safe welding without splashes and traditional welding can be carried out. If the mold is requested with Ref **LsVIP**, the mold already includes the cover.
3. Our ignition system allows ignition by remote control and with igniter.
4. Our remote ignition system uses a removable mold cover allowing a significant reduction of the smoke of the execution and canceling the possible projections coming from the aluminothermic reaction.
5. It is the best solution to comply with the most demanding safety conditions in this area of thermite welding.
6. Thanks to the versatility of the LsVIP process, the user or the client does not have to use other tools, other utensils and there is no need to change the conventional ignition system or to enlarge or modify your stock of material and you will never forget the ignition powder and therefore you can always weld.

Virtual Reality Training

116

Copper aluminothermic welding



Welcome to our Virtual Reality Center

Discover our virtual classroom and experience training in LsVIP aluminothermic welding using a virtual reality system that shows you all the necessary steps and allows you to acquire the skills you need to do real welding.

Find out more on www.klk.es



MEV Virtual Training Module

Electric Cable Welding Procedure.

• **Reference:**

Aluminothermic Welding Procedure Virtual Training Module **LsVip**.

• **Coded:** 14321

- Application that simulates the complete aluminothermic welding procedure.
- User is guided by text instructions during the procedure.
- The procedure is guided to prevent wrong choices at any stage.
- You cannot go to the next step without having correctly carried out the previous one.

• **Contents:**

- 1 HTC VIVE VR goggles.
- 2 sensors.
- 2 controls.
- 1 rugged carrying case.
- Software with 3 licenses.

• **Recommended hardware:**

- CPU: Intel 7, equivalent or higher.
- OS: Windows 7 64-bit (Service pack 1) or higher.
- Monitor: At least one, Full HD.
- HTC- VIVE standard kit with base stations and controls.
- In addition to the cables included in the HTC-VIVE system, a "Mini Display Port" < - > "HDMI" cable is required to be able to clone the image of the laptop on any TV with HDMI input.



Welding procedure ELPA- Tubo

Welding of electric cable to steel pipe



The **ELPA-Tubo KLK-weld** welding process offers the best solution for the electrical connection of copper cable on steel pipe in order to carry out cathodic protection of the pipe. The result is a connection with a very low electrical resistivity and a high mechanical resistance without modifying the steel of the pipe because its temperature never exceeds 450 °C.

Thanks to the fact that the clamping mechanism of the mold on the tube does not include an embracing element, it is not necessary to completely strip the tube to be welded, it suffices to discover only its upper part.

The electrical resistance of the connection is less than $10^{-4} \Omega$, and the resistance to mechanical shear at the plate / tube junction is greater than 25 kN.

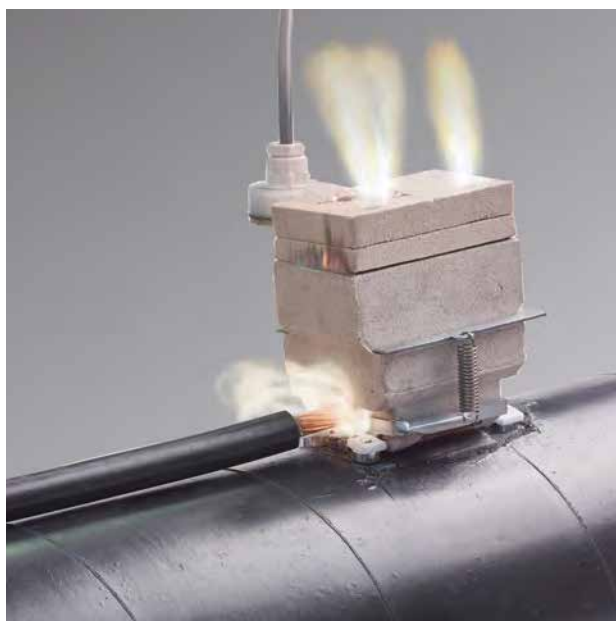

Unlike other welding procedures, the ELPA-KLK welding tube procedure does not affect the tube steel. A micrographic study of the union by capillary welding between plate and tube reveals that the structure of the steel of the tube remains unchanged and without microcracks.

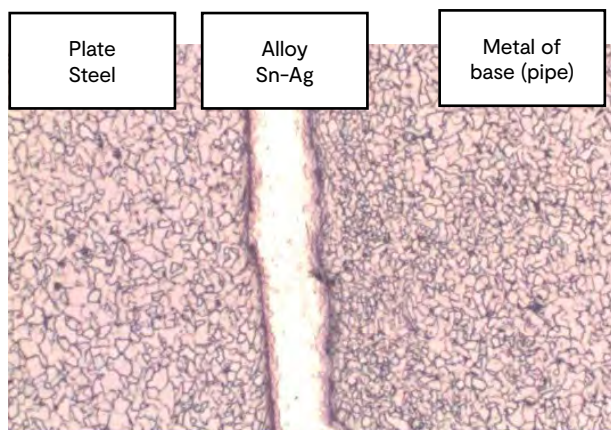

The **ELPA-Tube KLK-weld** welding procedure combines aluminothermic welding and tin-silver capillary welding, so that the latter uses part of the heat generated in the former. A ferritic steel plate is interposed between the conductive cable and the tube, absorbing the thermal impact of the thermite flow, and the plate being welded to the end of the cable. The plate incorporating a tin alloy on the contact side with the flat tube, the final union between the plate and the tube takes place due to the combination of the heat which melts this alloy and the force of a mechanism which presses the plate against the tube during solidification (force necessary to obtain a capillary welding without defects).

7. Copper aluminothermic welding /

7.11 Elpa Tubo

The KLPA **ELPA-Tubo** welding kit includes:

- Ceramic mold comprising a steel plate, a cable entry ring, a sealing disc, seals, a fuse cover for remote ignition and the clamping mechanism.
- Aluminothermic and ignition powder cartridge for welding.
- Flow dose.
- Additional sockets for other cable sections.
- User manual.

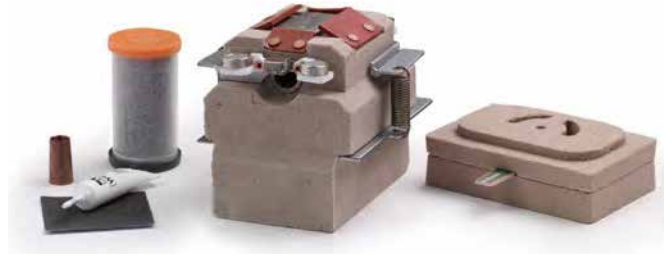

Each kit can be used in tubes of any diameter and is useful for soldering cables of different sections. Examples of possible kits are:

Denomination	Possible cables (*)		
Kit ELPA- Tubo 6 - 25	6 mm ²	25 mm ²	
Kit ELPA- Tubo 10 - 16 - 35	10 mm ²	16 mm ²	35 mm ²
Kit ELPA- Tubo 50 - 70	50 mm ²	70 mm ²	

(*) It is necessary to specify, in addition to the section, the diameter of each cable.

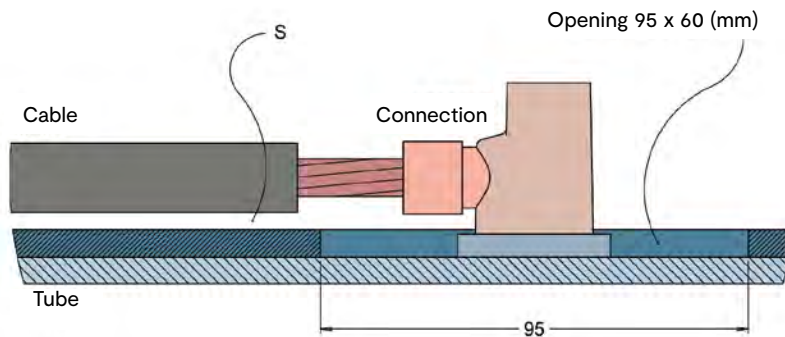

The area to be protected includes the opening made in the insulation of the tube, dimensions 95 x 60 (mm), the end of the cable from which the insulation had been removed over a length of 50 mm and the connection itself. The space between the cable and tube insulation (S) promotes the flow of coating resin in this area.

The ignition of the charge is carried out remotely, using the **KLK-weld** remote ignition device, with the possibility of also using the traditional ignition gun.



Quick and easy to use

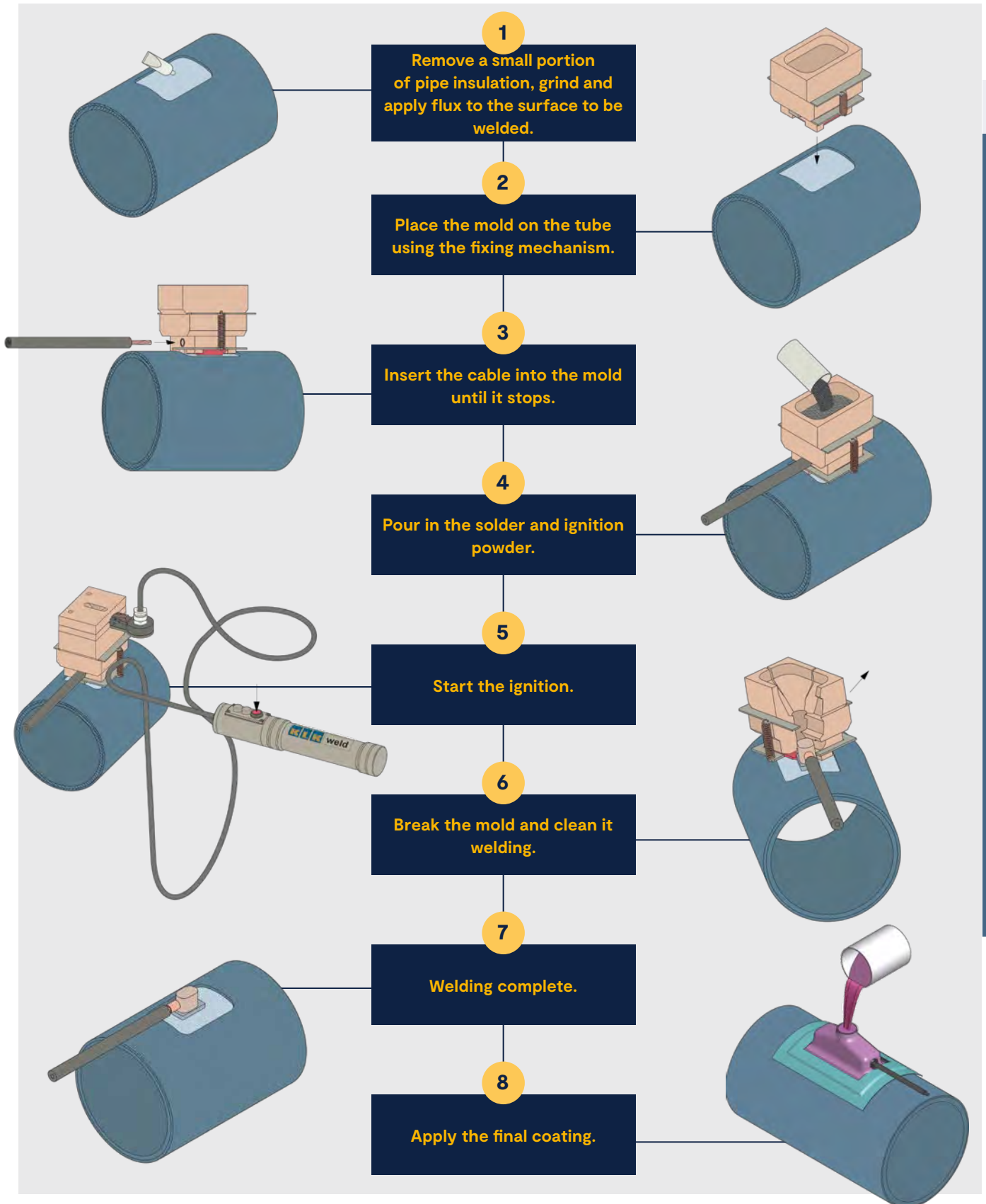

Advantages of the ELPA-Tubo process

Advantages of the new low temperature welding process for electrical connections of conductive cables to the surface of steel pipes in gas pipelines, for cathodic protection of pipes.

The advantages of this low temperature welding process, which we have commercially called Elpa-Tubo, are listed below:

1. The connections obtained have excellent electrical conductivity.
2. The connections obtained have a high mechanical resistance.
3. The internal structure of the steel tube is not changed.
4. Ease and speed of execution.
5. Absolute reliability.
6. To carry out welding, it is not necessary to completely dig up the pipe, it suffices to uncover its upper part.
7. Competitive price.
8. The same kit can be used in pipes of different diameters (see).
9. Possibility of providing kits that can be used with cables of different sections.
10. Possibility to light the charge remotely.
11. Possibility of being used on active pipes without having to cancel the supply or transport.

Method of welding ELPA

Method for welding electrical connections of copper cable to the rail pad



The **ELPA KLK-weld** soldering process offers the best solution for soldering copper cables to the rail base. The result is a connection with a very low electrical resistivity and a high mechanical resistance without modifying the steel of the rail because its temperature never exceeds 600 °C.



7. Copper aluminothermic welding /

7.12 ELPA



The electrical resistance in the connection is less than $10^{-5} \Omega$, and the mechanical shear resistance in the rail / plate joint is greater than 50 kN.

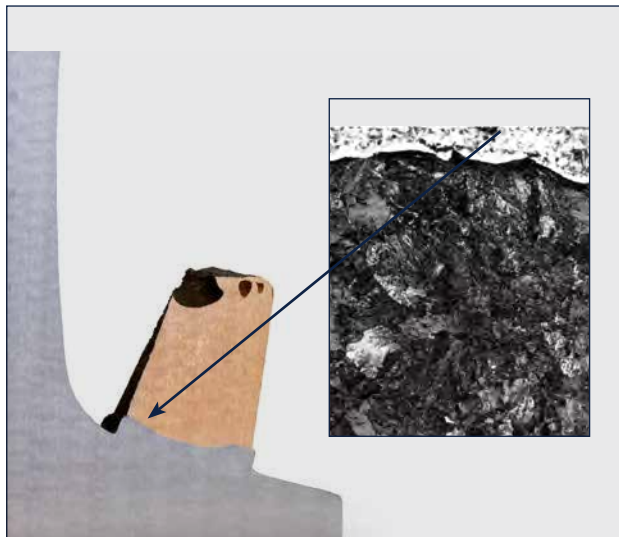

Unlike other welding processes, the **ELPA KLK-weld** process does not alter the steel of the rail. A micrographic study of the capillary weld connection between the plate and the rail reveals that the steel structure of the rail remains unaltered and free of microcracks.

The **ELPA KLK-weld** welding process combines aluminothermic welding processes and soldering by tin / silver brazing. The second takes advantage of the heat produced by the first. A small plate placed between the cable and the rail pad absorbs the heat of the aluminothermic reaction and remains welded to the end of the cable. The plate is made of a tin / silver alloy on the side of the rail. The final union between the plate and the rail is produced by the combination of the heat which melts the alloy and the force of the spring clip which presses the plate against the rail during the solidification process.



The spring clip acts as a system for fixing the mold to the rail pad, being this system valid for most rail profiles.

The **ELPA KLK-weld** Kit includes:

- a. Sand mold with steel plate, copper tip for cable entry, metal disc, cover and spring clip.
- b. Cartridge with solder powder and the ignition powder.
- c. Flow dose.
- d. Notice - Instructions for use.

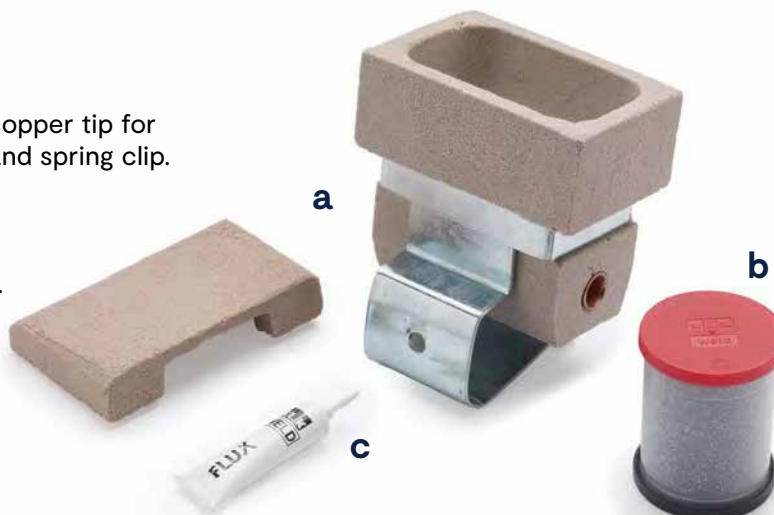

ELPA KLK-weld kits are specifically manufactured for use with copper cables of sections 10 to 240 mm². They can be used on most rails: AREA, BS, UIC, U, S, RN, etc. Examples of possible kits are:

Denomination	Application (*)
Kit ELPA 10	Copper cable 10 mm ² (Ø4,05 mm)
Kit ELPA 35	Copper cable 35 mm ² (Ø7,6 mm)
Kit ELPA 50	Copper cable 50 mm ² (Ø9,2 mm)
Kit ELPA 70	Copper cable 70 mm ² (Ø10,9 mm)
Kit ELPA 95	Copper cable 95 mm ² (Ø12,6 mm)
Kit ELPA 120	Copper cable 120 mm ² (Ø14,3 mm)
Kit ELPA 150	Copper cable 150 mm ² (Ø15,6 mm)
Kit ELPA 185	Copper cable 185 mm ² (Ø17,6 mm)
Kit ELPA 240 R	Copper cable 240 mm ² (Ø20,0 mm)
Kit ELPA 240 F	Câble en cuivre 240 mm ² (Ø23,0 mm)
Kit ELPA 12	Bolt Ø12 mm (**)

(*) Consult in case of other sections and / or diameters.

(**) The bolt can be welded to an aluminum cable or be part of a Cu Al bimetal terminal.

There is the possibility of using the **LsVIP KLK-weld** ignition procedure which avoids the escape of projections from the crucible, reduces smoke emissions and makes it possible to ignite at a certain distance. For this, the following elements are necessary:

- a. Cover ELPA LsVIP.
- b. Remote ignition device.
- c. Fuses (one unit per weld).



Simple and easy to use

126

Copper aluminothermic welding

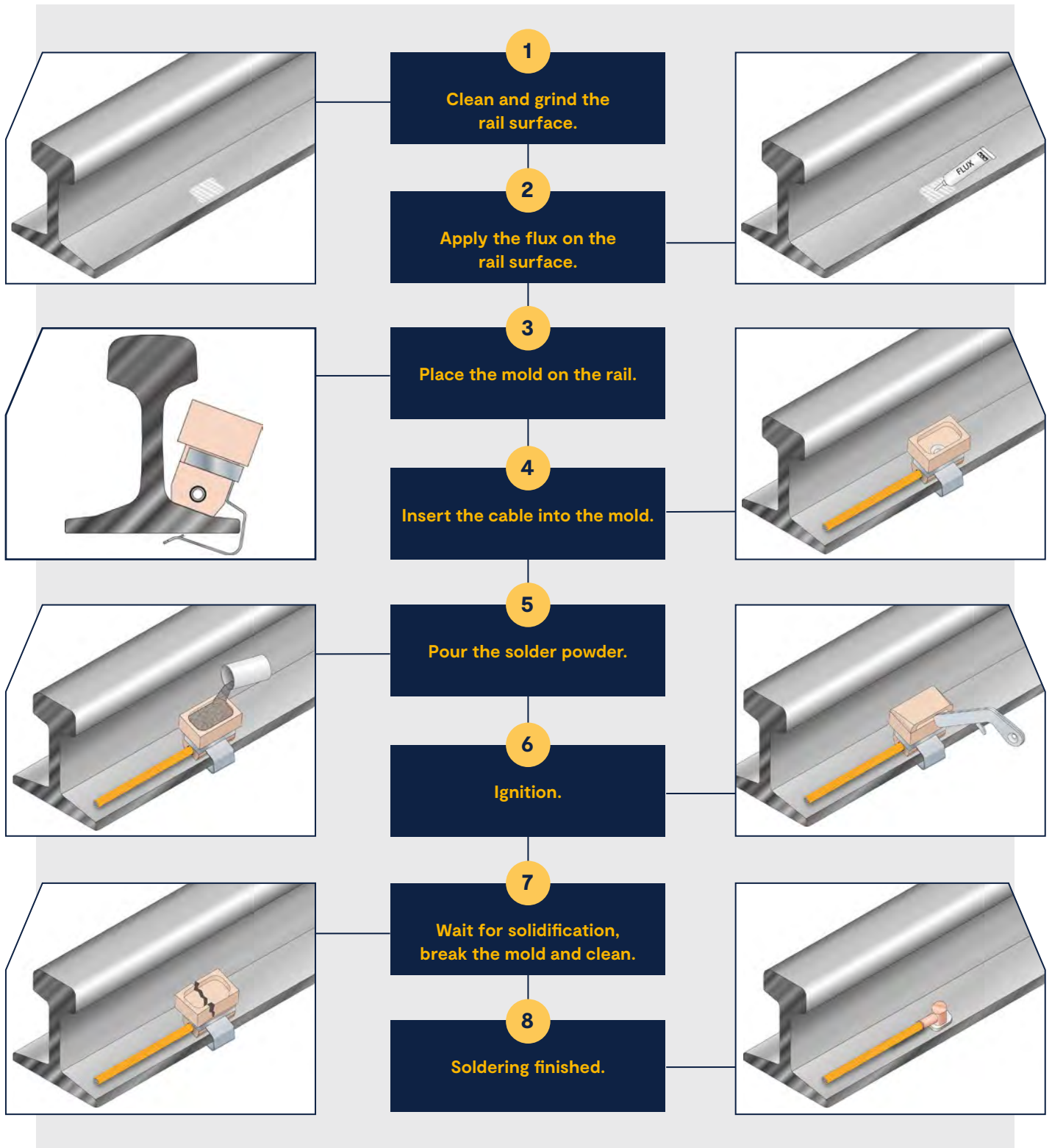

Advantages of the procedure ELPA welding

The advantages of this low temperature welding procedure, which we have commercially called ELPA are listed below:

1. The connections obtained have excellent electrical conductivity.
2. The connections obtained have a high mechanical resistance.
3. The internal structure of the rail steel is not changed.
4. Excellent behavior against corrosion.
5. Ease and speed of execution.
6. Absolute reliability.
7. Ability to activate charging remotely.
8. Competitive price.



Notes

Lined area for notes, consisting of multiple horizontal rows of alternating light grey and white background.

Notes

Blank lined area for notes, consisting of alternating light and dark grey horizontal bands.



Notes

Blank lined area for notes.



UL certificate in several
copper welding references.

Earthing. Copper welding.



PANDROL

www.klk.es

KLK

Camino de la Peñona, 38-B
33211 Gijón (Asturias) · Spain

Tel. +34 985 321 850

Fax. +34 985 312 820

comercial@klk.es

KLK FRANCE

Rue Fourcroy
59494 Petite Forêt · France
info@klk.es

KLK weld