



Ficha técnica de producto

CARTUCHO KLK-WELD

Descripción

Envoltura tubular de polietileno dividida interiormente en dos compartimentos estancos a ambos extremos para fácil diferenciación en el proceso de soldadura.

Polvo aluminotérmico, se encuentra en la cavidad del bote con la tapa de color y en mayor proporción, siendo símbolo identificativo según código de colores.









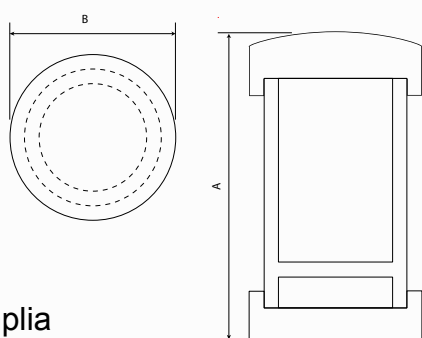

Polvo Ignición, Se encuentra en la cavidad del bote con la tapa negra, siendo este el componente que activa la ignición en el proceso exotérmico.

Especificaciones

Material Envoltente Polietileno

Código Aduanero 38101000



Código	REF.	COLOR.	A/B	Peso(g)	Unid
			mm	Embalaje	
16001	C-15	 Gris claro	30/35	590	20
16002	C-25	 Gris oscuro	30/35	820	20
16003	C-32	 Violeta	41/35	960	20
16004	C-45	 Blanco	41/35	1140	20
16005	C-65	 Amarillo	54/35	820	10
16006	C-90	 Naranja	63/35	1090	10
16007	C-115	 Rojo	82/35	1390	10
16008	C-150	 Marron	58/40	1750	10
16009	C-200	 Azul	71/40	2210	10
16010	C-250	 Verde	93/40	2620	10